



Uw ideale kantoorgids



2016 - 2017

In deze catalogus vindt u naast de gekende klassiekers tevens heel wat nieuwigheden. Al vele jaren staat Meabi synoniem voor een breed gamma kantoormeubelen en kantoor materiaal.

En dit uiteraard tegen zeer competitieve prijzen!

Onze regionale verdelers staan bovendien steeds klaar om u met raad en daad te helpen. Hun competentie en service zullen u zeker helpen bij de inrichting van uw kantoorruimte.

Niets kan de dialoog met een echte vakman vervangen.

Op zoek naar de beste prijs-kwaliteitverhouding?

Ontdek dan gauw ons aanbod in deze catalogus en neem contact op met onze verdelers.

Alle producten zijn leverbaar uit voorraad voor een snelle levering in uw kantoor!

KANTOORMEUBILAIR

Kantoormeubelen	3 tot 31
Accessoires kantoormeubelen	32 tot 33
Directiemeubelen	34 tot 43

KANTOORSTOELEN

Directiestoelen	44 tot 51
Operatorstoelen	52 tot 71
Stoelen voor bezoekers, vergaderzalen, groepsruimtes	72 tot 84
Onthaalstoelen en -zetels	85 tot 87
Kleurstalen van stoelen en mechanismen	88 tot 89

Veelzijdige tafels, vergadertafels	90 tot 93
Metalen kasten	94 tot 105
Kapstukken	106
Vloerbescherming	107
Budgetproducten	108 tot 115

- *Meer dan 20.000 producten beschikbaar!*
- *De beste prijs-kwaliteitverhouding op de markt!*
 - *Alles is leverbaar uit voorraad!*
 - *Bekwame verdelers in uw buurt!*
- *Analyse van uw behoeften + professioneel advies!*
 - *Snelle levering en installatie!*
 - *Efficiënte dienst na verkoop!*

Exclusief btw • Artikelen uit voorraad • SNELLE LEVERING

Espace



Gamma klaptafels, perfect geschikt voor elk gebruik.
Polyvalente tafels voor groepsruimtes.
U wint plaats en ze zijn gemakkelijk op te stellen.

GARANTIE
3
jaar

AFMETINGEN	120 x 80	140 x 80	160 x 80	180 x 80	Kit met 4 haken voor verbinding van bladen
REF	ESP128	ESP148	ESP168	ESP188	ESPKIT4CR
€	274	294	299	309	14



Assemblage van tafels onderling door haaksysteem

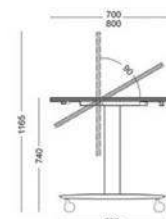

- Structuur uitgerust met een metalen balk onder het blad
- Speciaal mechanisme om het blad op te klappen
- Onderstel op wielen met remmen
- Gemelamineerd blad van 25 mm dik
- Hoogte tafels 74 cm

BLAD- KLEUREN				KLEUREN ONDERSTEL		
	Wit	Medium esdoorn	Havanna		Wit	Aluminium
	BC	EM	HA		BW	AL

Domino



Technische informatie

Werkblad

- Gemelamineerd blad met hoge weerstand dat voldoende tegengewicht vormt, dikte 25 mm dichtheid 725 kg/m³. E1-gecertificeerd.
- ABS-stootranden 2 mm.
- Metalen tussenstukken voor bevestiging onderstellen.

Onderstel

- Metalen "L"-onderstel met laterale vrije ruimte met kabelstijl in elke poot en scheiding van de stromen.
- Epoxyverf: aluminium (AL), wit (BL) of antraciet (GA).
- Steldoppen voor nivellering.

Conventioneel, maar altijd traditioneel, de gedecentreerde L-poot kenmerkt zich ook door zijn robuustheid en zijn functionaliteit en maakt een gemakkelijke laterale vrije ruimte mogelijk. Het in de hoogte verstelbare onderstel biedt de gebruiker een perfecte ergonomie.



Structuur

- Metalen structuurbalk.

Opties

- Horizontale sleuf onder het blad voor kabeldoorgang.
- Houten beenafscherming.
- In de hoogte verstelbaar onderstel.

Domino



GARANTIE
5
jaar

Houden ladeblok Metalen ladeblok

D/G Moet worden vervangen door de keuze voor het soort bijzetbureau: D: rechts / G: links

Rechte bladen diepte 80

AFMETINGEN	80 x 80	120 x 80	140 x 80	160 x 80	180 x 80	200 x 80
REF	D088	DO128	DO148	DO168	DO188	DO208
€	180	199	225	229	239	244

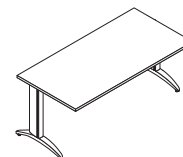



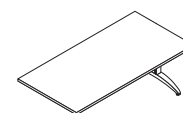

Rechte bladen diepte 80 volgende

AFMETINGEN	80 x 80	120 x 80	140 x 80	160 x 80	180 x 80	200 x 80
REF	D088S	DO128S	DO148S	DO168S	DO188S	DO208S
€	129	149	174	179	189	194

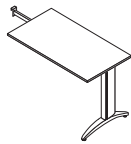

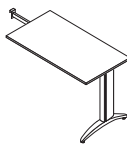
Bijzetbureau

AFMETINGEN	80 x 60			120 x 60		
						
REF	DORD86D/G	DOR86-309	DOR86-CCH	DORD126D/G	DOR126-309	DOR126-CCH
€	130	349	299	154	399	319

KLEUREN BLADEN & HOUTEN LADEBLOKKEN					METAAL-KLEUREN			
	Wit	Medium esdoorn	Havanna	Wengé		Wit	Aluminium	Antraciet
	BC	EM	HA	NG		BW	AL	GA

Andere accessoires zie pagina 32

Domino



Compacte bladen

Houden ladeblok Metalen ladeblok

AFMETINGEN	160 x 120	180 x 120	160 x 162		180 x 162	
Schema's: bijzetbureau rechts						
REF	DO1612D/G	DO1812D/G	DOR1612D/G309	DOR1612D/GCCH	DOR1812D/G309	DOR1812D/GCCH
€	325	335	614	559	624	569

Uitbreidingen

Sleuf Kabelsteun

AFMETINGEN	Hoek 90°	80 x40	120 x 60	160 x 60	60	14
REF	DO202	EX8040	EX1260	EX1660	MARSUP	ACCLIP1
€	78	54	84	119	25	3

Ladeblokken BH + TOP

Mobiele ladeblokken

Pennenlade

AFMETINGEN	3L + 1L pennenlade P60	2L + 1L hangmappen P60	2L + 1L hangmappen P80	Mobiel 2L	Mobiel 3L			
REF	DOCAH316	R816	R880	NWA59M1SFT	DOCAM306	NWA59M1SSS	PLUMIERROMA	EN.TP
€	289	239	259	169	219	169	12	9

Domino



Scheidingswand in gesatineerd wit melkplexiglas

Stoffen akoestische scheidingswand

AFMETINGEN	120 x 35	160 x 35	80 x 39	120 x 39	140 x 39	160 x 39
REF	PE-12035VE	PE-16035VE	PEA-8039	PEA-12039	PEA-14039	PEA-16039
€	159	184	188	229	272	294

STOFKLEUREN LEVERINGSTERMIJN 4 WEKEN

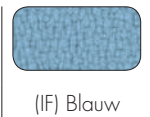
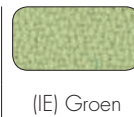

Ronde tafels

Tonvormige tafels

AFMETINGEN	Ø 120		Ø 120		200 x 120 x 80	240 x 120 x 80	
REF	TR120		TR4P120		MIKC2012	MIKC2412	
€	295		229		579	649	

Houten kasten

Bovenbladen metalen kasten

AFMETINGEN	80 x 45 x 77	80 x 45 x 184	80 x 45 x 184	80 x 45 x 184	80 x 43	100 x 43	120 x 43
Legplanken	1	4	4	4			
REF	RGAB7280	RGAH19890	RGAHV19890	RGAHSP19890	TOP8043	TOP10043	TOP12043
€	199	449	649	319	42	45	48

Domino



Gemelamineerde beenafscherming

AFMETINGEN	80	120	160	180
REF	VDF-80	VDF-120	VDF-160	VDF-180
€	40	46	59	64

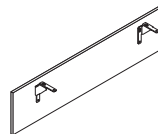

Alu kabeldoorgang

AFMETINGEN	ø 80
REF	ACOBT
€	6



Structuurbalk



Verticale kabeldoorvoer via in de poot geïntegreerde kabelsleuf

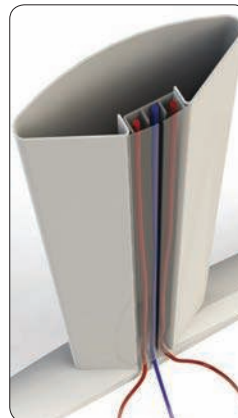

In de hoogte verstelbaar onderstel



Horizontale kabeldoorvoer via sleuf onder het blad met mogelijkheid om stekkerblokken te plaatsen



Verstelbare onderstellen recht bureau	+60€
Verstelbare onderstellen compact bureau	+90€

Andere accessoires zie pagina 32

Mikado



Technische informatie

Werkblad

- Gemelamineerd blad met hoge weerstand dat voldoende tegengewicht vormt, dikte 25 mm dichtheid 725 kg/m³. E1-gecertificeerd.
- ABS-stootranden 2 mm.
- Metalen tussenstukken voor bevestiging onderstellen.

Onderstel

- "Boogachtig" metalen onderstel.
- Epoxyverf: aluminium (AL), wit (BL) of antraciet (GA).
- Steldoppen voor nivellering.

Structuur

- Metalen structuurbalk met verbindingshoek voor dragende ladeblok.

Opties

- Kabelstijl langs een poot.
- Enkelvoudige of dubbele kabelgoot, bevestigd aan het structuurdeel.
- Houten beenafscherming.
- In de hoogte verstelbaar onderstel.

Met zijn "boogachtige" onderstel is het MIKADO-assortiment bij uitstek het essentiële en functionele gamma voor een moderne bureauconfiguratie.

Dankzij de uitgebreide opties biedt het gamma de mogelijkheid om de opbergruimtes te optimaliseren.



Mikado



Houden ladeblok Metalen ladeblok

Rechte bladen diepte 80

AFMETINGEN	80 x 80	120 x 80	140 x 80	160 x 80	180 x 80	200 x 80
REF	MIK88	MIK128	MIK148	MIK168	MIK188	MIK208
€	214	232	258	262	269	279

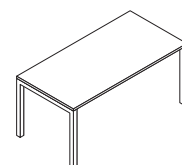





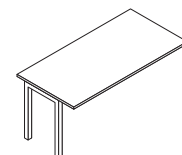

Rechte bladen diepte 80 volgende

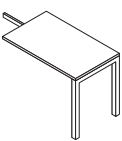
AFMETINGEN	80 x 80	120 x 80	140 x 80	160 x 80	180 x 80	200 x 80
REF	MIKS88	MIKS128	MIKS148	MIKS168	MIKS188	MIKS208
€	139	162	188	191	199	205

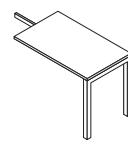

Bijzetbureau

AFMETINGEN	80 x 60			120 x 60		
						
REF	MIKR86	MIKR86-309	MIKR86-CCH	MIKR126	MIKR126-309	MIKR126-CCH
€	148	349	299	170	399	319

Gemelamineerde beenafscherming

AFMETINGEN	80	120	160	180
REF	VDF-80	VDF-120	VDF-160	VDF-180
€	40	46	59	64

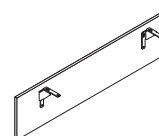

Andere accessoires zie pagina 32

Mikado

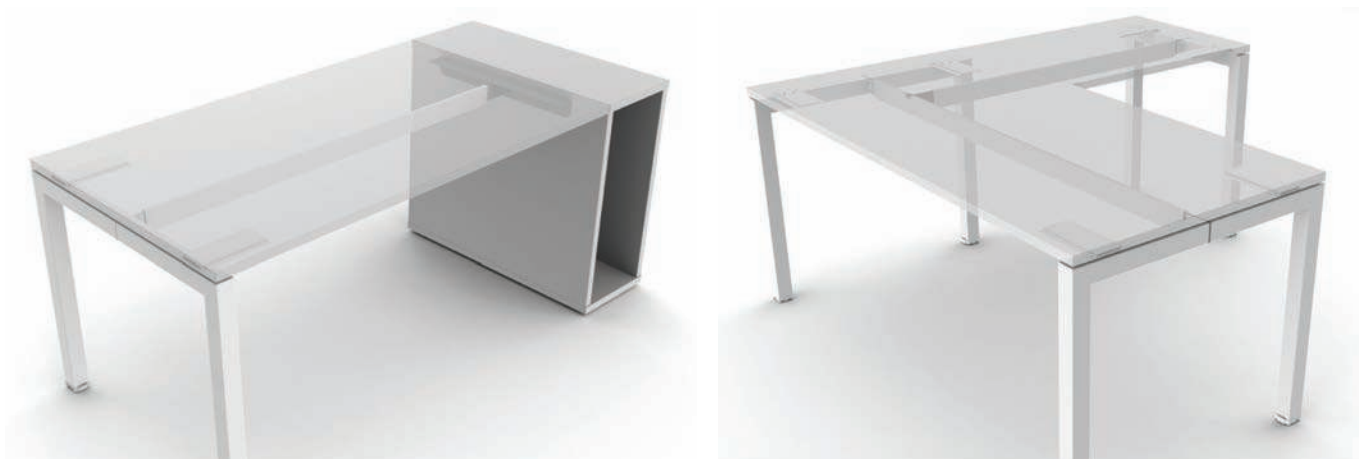

Compacte bladen 90°

Compacte bladen 90° volgende

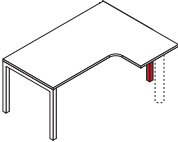
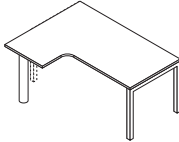
AFMETINGEN	160 x 120	180 x 120	160 x 120	180 x 120
	Schema's: bijzetbureau rechts 		Schema's: bijzetbureau links 	
REF	MIK1612D/G	MIK1812D/G	MIKS1612D/G	MIKS1812D/G
€	349	359	279	289

Volledige compacte bladen 90°

Volledige compacte bladen 90° volgende

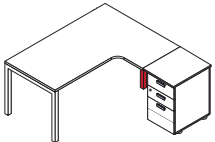
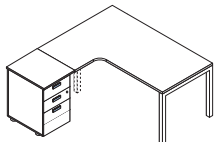
AFMETINGEN	160 x 162		180 x 162		160 x 162		180 x 162	
	Schema's: bijzetbureau rechts 				Schema's: bijzetbureau links 			
REF	MIK1612 D/G/309	MIK1612 D/G/CCH	MIK1812 D/G/309	MIK1812 D/G/CCH	MIKS1612 D/G/309	MIKS1612 D/G/CCH	MIKS1812 D/G/309	MIKS1812 D/G/CCH
€	639	589	649	599	569	519	579	529

D/G Moet worden vervangen door de keuze voor het soort bijzetbureau: D: rechts / G: links

Houden ladeblok Metalen ladeblok

Mikado



Rechthoekige bladen tegenover elkaar

Bladen tegenover elkaar vervolg

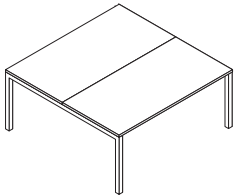
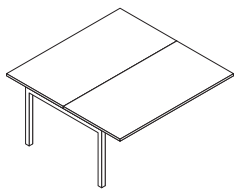
AFMETINGEN	120 x 160	140 x 160	160 x 160	180 x 160	200 x 160	120 x 160	140 x 160	160 x 160	180 x 160	200 x 160
										
REF	MIKFF 1216	MIKFF 1416	MIKFF 1616	MIKFF 1816	MIKFF 2016	MIKFFS 1216	MIKFFS 1416	MIKFFS 1616	MIKFFS 1816	MIKFFS 2016
€	408	460	465	482	490	289	342	348	364	372

Rechthoekige bladen bench 165

Bladen bench 165 volgende

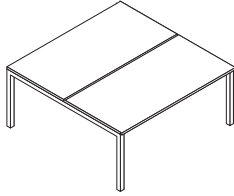
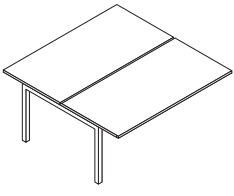
AFMETINGEN	120 x 165	140 x 165	160 x 165	180 x 165	200 x 165	120 x 165	140 x 165	160 x 165	180 x 165	200 x 165
										
REF	MIKFF 12165	MIKFF 14165	MIKFF 16165	MIKFF 18165	MIKFF 20165	MIKFFS 12165	MIKFFS 14165	MIKFFS 16165	MIKFFS 18165	MIKFFS 20165
€	414	466	471	488	496	295	348	354	370	378

Mikado



Rechthoekige bladen 90° tegenover elkaar

Bladen 90° tegenover elkaar vervolg

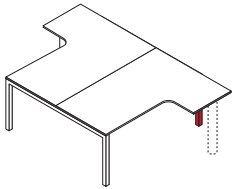
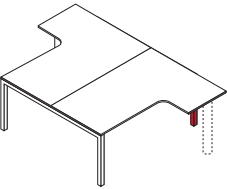
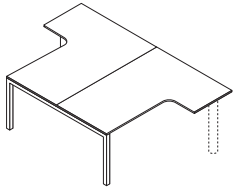
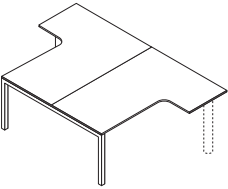
AFMETINGEN	160 x 240	180 x 240	160 x 240	180 x 240
				
REF	MIKFF1624	MIKFF1824	MIKFFS1624	MIKFFS1824
€	624	640	506	522

Compacte bladen 90° bench 165

Compacte bladen 90° bench 165

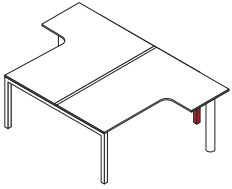
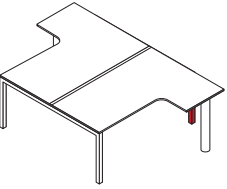
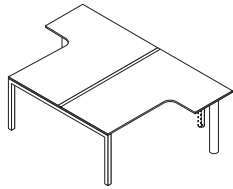
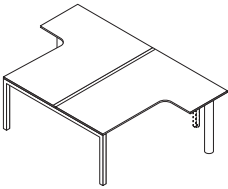
AFMETINGEN	160 x 245	180 x 245	160 x 245	180 x 245
				
REF	MIKFFC1624	MIKFFC1824	MIKFFCS1624	MIKFFCS1824
€	630	646	512	528

Mikado



Andere accessoires zie pagina 32

Houden ladeblok

Metalen ladeblok

Scheidingswand in gesatineerd wit melkplexiglas

Stoffen akoestische scheidingswand

AFMETINGEN	120 x 35	160 x 35	80 x 39	120 x 39	140 x 39	160 x 39
REF	PEB-12035VE	PEB-16035VE	PEB-8039	PEB-12039	PEB-14039	PEB-16039
€	174	199	196	239	286	299

STOFKLEUREN LEVERINGSTERMIJN 4 WEKEN

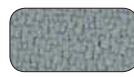

(IA) Grijs



(IB) Ivoor



(IC) Rood



(IE) Groen

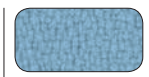

(IF) Blauw

Ladeblokken BH + TOP

Mobiele ladeblokken

Pennenlade

AFMETINGEN	3L + 1L pennenlade P60	2L + 1L hangmappen P60	2L + 1L hangmappen P80	Mobiel 2L	Mobiel 3L			
REF	MIKCAH316	R816	R880	NWA59M1SFT	MIKCAM306	NWA59M1SSS	PLUMIERROMA	EN.TP
€	289	239	259	169	219	169	12	9

KLEUREN BLADEN &
HOUTEN LADEBLOKKEN



Wit

BC



Medium esdoorn

EM

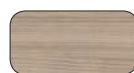

Havanna

HA



Wengé

NG

METAAL-KLEUREN



Wit

BW



Aluminium

AL



Antraciet

GA

Mikado

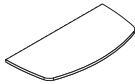
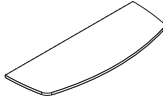
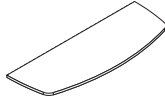

Uitbreidingen

AFMETINGEN	80 x 40	120 x 60	160 x 60	165 x 60
				
REF	EX8040	EX1260	EX1660	EX16760
€	54	84	119	125

Houten kasten

Bovenbladen metalen kasten

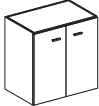
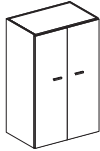
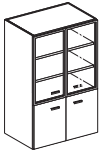
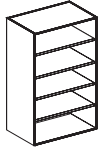
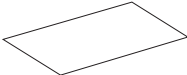
AFMETINGEN	80 x 45 x 77	80 x 45 x 184	80 x 45 x 184	80 x 45 x 184	80 x 43	100 x 43	120 x 43
							
Legplanken	1	4	4	4			
REF	RGAB7280	RGAH19890	RGAHV19890	RGAHSP19890	TOP8043	TOP10043	TOP12043
€	199	449	649	319	42	45	48

Mikado



SACAVI

Kabeldoorvoersystemen

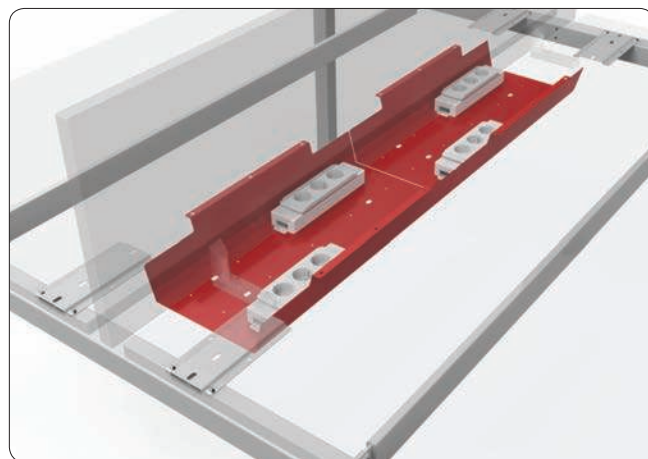

Horizontale kabeldoorvoer met dubbele kabelgoot:

- Aan de structuurbalk bevestigde kabelgoot. Ideaal om elektriciteitsdozen te plaatsen

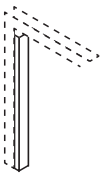
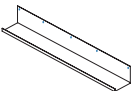
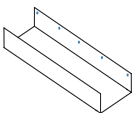

Toebehoren

Andere accessoires zie pagina 32

AFMETINGEN		60	60	ø 80
				
	Kabelstijl	Enkelvoudige kabelgoot	Dubbele kabelgoot	Alu kabeldoorgang
REF	SACAVI	MARSUP	BD60	ACOBT
€	22	25	46	6

Mikado



In de hoogte verstelbare onderstellen

In de hoogte verstelbare verlengstukken:

- De verlengstukken komen in de plaats van de doppen
- Manuele regeling van de hoogte van elk verlengstuk (72 tot 86 cm)

In de hoogte verstelbaar verlengstuk **22€/stuk** MIKRH1

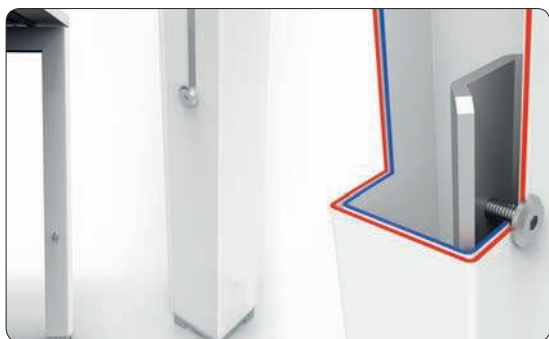

Manueel in de hoogte verstelbare onderstellen:

- Manuele regeling van de hoogte (65 tot 85 cm)

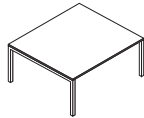
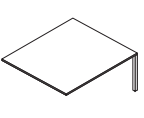

Verstelbaar onderstel recht bureau	+125€	H1 (te vermelden na ref. bureau)
Verstelbaar onderstel compact bureau	+190€	H2 (te vermelden na ref. bureau)

Vierkante tafels en vierkante tafels vervolg

AFMETINGEN	140 x 140		140 x 140	
REF	MIK1414		MIKS1414	
€	489		369	

Ronde tafels

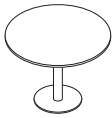
Tonvormige tafels

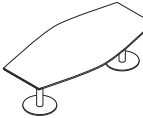
AFMETINGEN	Ø 120		Ø 120		200 x 120 x 80	240 x 120 x 80	
REF	TR120		TR4P120		MIKC2012	MIKC2412	
€	295		229		579	649	

Tornado

De efficiëntie die het verschil maakt





Werkcomfort vóór alles.

Het Tornado-meubilairsysteem biedt u een grote efficiëntie bij de inrichting van uw werkruimtes. Om zich beter op de belangrijkste taken te kunnen concentreren, moet de inrichting van een bureau berusten op de eenvoud en op verfijnde vormen. De structuur van het Tornado-meubilair is noch opdringerig noch imposant. Het vervult dus zijn functie en steekt bovendien uit boven de rest



Tornado - vierkante poten

Bureaus en bijzetbladen (Leveringstermijn 4 weken)

De bureaus zijn verkrijgbaar in verschillende vormen en in een brede waaier van afmetingen. De bijzetbladen vormen een aanzienlijke uitbreiding van de werkoppervlakte.



- Bladen in spaanplaten van 25 mm van klasse E1
- Gemelamineerde dubbelzijdige afwerking
- Het draagframe zorgt voor de stabiliteit van de plaat
- Vierkante onderstellen (50*50 mm) in wit epoxy metaal of aluminium
- Alle bureaus kunnen worden uitgerust met verticale en horizontale kabelsleuven en scheidingschermen

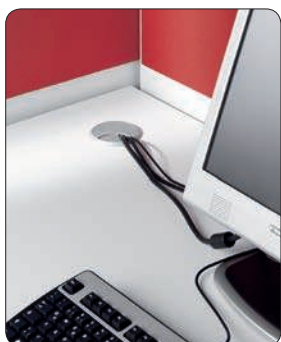

METAALKLEUREN		
	Wit (BW)	Aluminium (AL)

KLEUREN GEMELAMINEERDE PLATEN								
	Wit	Esdoorn	Beuk	Havanna	Calvados	Donkere notelaar	Lichte notelaar	Lichtgrijs
	BI	NE	NB	NT	CV	NN	NP	MP
								
	Antraciet	Wengé	Zwart	Iep	Eik			
	MS	NG	CC	NO	NA			

Tornado-bureaus - vierkante poten

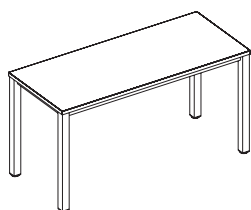

Rechte bladen

AFMETINGEN	80x60	100x60	120x60	80x80	100x80	120x80	140x80	160x80	180x80	200x80
REF	TOR86	TOR106	TOR126	TOR88	TOR108	TOR128	TOR148	TOR168	TOR188	TOR208
€	136	146	150	142	156	159	178	184	208	214

Rechte bijzetbladen

AFMETINGEN	80x60	100x60
REF	TOR86R	TOR106R
€	94	104

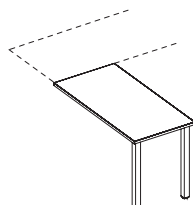

Hoek 90°

AFMETINGEN	80x80
REF	TOR202
€	89

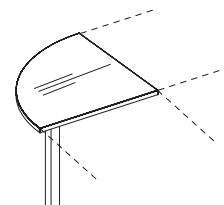

Gelieve de keuze van het onderstel en de kabeldoorgang te vermelden

OPTIES	Vast onderstel		N
	In de hoogte verstelbaar onderstel van 72 tot 84 cm	5€ /per poot	H
OPTIES	Ronde kabeldoorgang 80 mm links	6€	L
	Ronde kabeldoorgang 80 mm rechts	6€	R
	Zonder kabeldoorgang		N

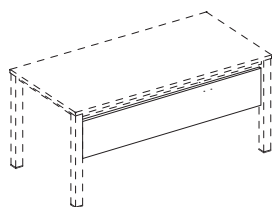
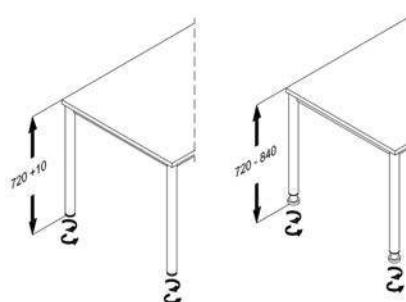

Beenafscherming

AFMETINGEN	60	80	100	120	140	160	180	200
REF	TORVDF60	TORVDF80	TORVDF100	TORVDF120	TORVDF140	TORVDF160	TORVDF180	TORVDF200
€	29	30	32	35	36	42	46	50

Horizontale sleuven



AFMETINGEN	59	79	99	119
REF	TORGO60	TORGO80	TORGO100	TORGO120
€	25	27	30	31

Verticale slurf

AFMETINGEN	77
REF	TORGO77
€	40



Andere accessoires zie pagina 32

Tornado - plaatpoten



- Bladen in spaanplaten van 25 mm van klasse E1
- Gemelamineerde dubbelzijdige afwerking
- Structurele beenafscherming

Bureaus Tornado - Plaatpoten

(Leveringstermijn 4 weken)

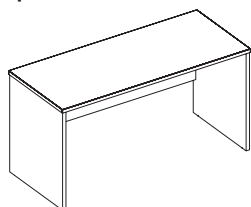

Rechte bladen

Kleuren zie pagina 22



AFMETINGEN	80x60	100x60	120x60	80x80	100x80	120x80	140x80	160x80	180x80	200x800
REF	TOR86P	TOR106P	TOR120P	TOR88P	TOR108P	TOR128P	TOR148P	TOR168P	TOR188P	TOR208P
€	84	94	98	102	108	126	134	152	172	178

Tornado - scheidingschermen





(Leveringstermijn 4 weken) Alle scheidingschermen zijn in spaanplaten van 18 mm dik. Ze bieden niet alleen een visuele afscheiding, maar vergroten de werkoppervlakte in de kantoorruimte.

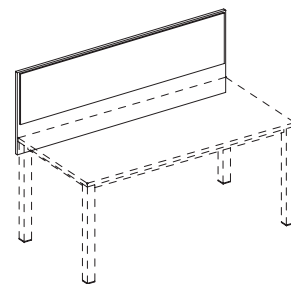

Scheidingschermen (gelieve de kleur te vermelden)

AFMETINGEN	80	100	120	140	160	180	200
REF	TORSEP80	TORSEP100	TORSEP120	TORSEP140	TORSEP160	TORSEP180	TORSEP200
€	88	96	126	130	140	158	170



						
LEVERINGSTERMIJN KLEUREN 4 WEKEN	Zwart XR 009	Blauw XR 026	Antraciet XR 046	Rood XR 079	Lichtgrijs XR 094	Groen XR 156



Opberglegplank

AFMETINGEN	L60 x P22 x H19
REF	TORTAB
€	45

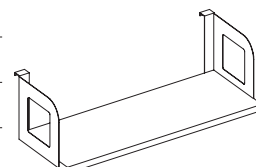

Tornado (leveringstermijn 4 weken)

Ladeblokken - Mobiele dientafeltjes of dientafeltjes voor multimedia

Ladeblokken

De ladeblokken zijn beschikbaar in twee versies: mobiele ladeblokken, die u onder het werkblad kunt schuiven, of vaste ladeblokken, met dezelfde hoogte als het bureau, die uw werkblad aanzienlijk vergroten. Alle ladeblokken zijn uitgerust met sloten, met een geïntegreerde pennenlade of een ingezette pennenlade.

- In spaanplaten van 18 mm en 25 mm van klasse E1, gemelamineerde afwerking
- Voorkant in spaanplaten van 16 mm van klasse E1, gemelamineerde afwerking
- Uitgerust met 4 wieltjes (waarvan twee met rem)

Mobiel dientafeltje



Esthetisch, multifunctioneel, voor een snelle toegang tot persoonlijke documenten. Uitgerust met slot en 4 wieltjes waarvan 2 met rem.

Dientafeltje voor multimedia

Mobiel multifunctioneel meubel, wordt gebruikt als drager voor multimedia-apparatuur tijdens vergaderingen of presentaties. Wordt ook gebruikt als informaticadrager. Uitgerust met een kabeldoorgang, alsook met 4 wieltjes waarvan 2 met rem.



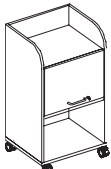

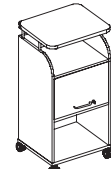
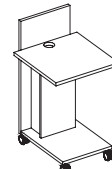

- In spaanplaten van 18 mm en 25 mm van klasse E1, gemelamineerde afwerking

Verrijdbaar dientafeltje

AFMETINGEN	B55 x D47 x H103 cm	B55 x D57,5 x H113 cm	B55 x D57,5 x H113 cm	B55 x D57,5 x H102 cm
				
REF	TORCD01	TORCD02	TORCD03	TORCD04
€	215	262	259	152



Houten ladeblokken met dezelfde hoogte als het bureau: H72 x B43 cm

AFMETINGEN	4 laden P60	4 laden P80	4 laden + pennenlade P60	4 laden + pennenlade P80	2 laden voor papierwaren 1 pennenlade 1 lade voor hangmappen P60	2 laden voor papierwaren 1 pennenlade 1 lade voor hangmappen P80
						
REF	TORCAH406	TORCAH408	TORCAH416	TORCAH418	TORCAH316	TORCAH318
€	274	286	292	305	278	290

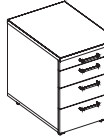
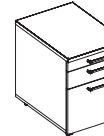
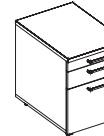
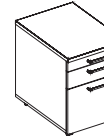
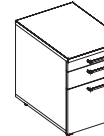

Houten mobiele ladeblokken: H60 x B43cm

AFMETINGEN	3 laden P60	3 laden P80	3 laden + pennenlade P60	3 laden + pennenlade P80	1 lade voor papierwaren 1 pennenlade 1 lade voor hangmappen P60	1 lade voor papierwaren 1 pennenlade 1 lade voor hangmappen P80
						
REF	TORCAM306	TORCAM308	TORCAM316	TORCAM318	TORCAM216	TORCAM218
€	209	215	228	245	222	235



Kleuren zie pagina 22

Tornado - kasten (Leveringstermijn 4 weken)



- Structuur in spaanplaten van 25 mm en 18 mm van klasse E1, gemelamineerde afwerking
- Klapdeuren in spaanplaten van 16 mm van klasse E1, gemelamineerde afwerking
- Metalen sokkel met verstelbare steldoppen
- Slot met set van 2 buigzame sleutels
- 3-puntssluiting vanaf een hoogte van 147 cm

GEMELAMINEERDE KLEUREN								
	Wit BI	Esdoorn NE	Beuk NB	Havanna NT	Calvados CV	Donkere notelaar NN	Lichte notelaar NP	Lichtgrijs MP
	Antraciet MS	Wengé NG	Zwart CC	Iep NO	Eik NA			

Klapdeurkasten B80 cm

AFMETINGEN	H74	H76,5	H111,7	H146,9	H183,9	H219,1
REF	TORAR8070	TORAR8080	TORAR80112	TORAR80150	TORAR80180	TORAR80200
€	199	206	248	336	439	458

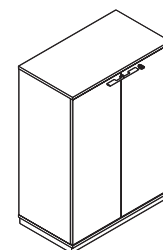

Klapdeurkasten B100 cm

AFMETINGEN	H74	H76,5	H111,7	H146,9	H183,9	H219,1
REF	TORAR1070	TORAR1080	TORAR10112	TORAR10150	TORAR10180	TORAR10200
€	235	252	306	445	499	562

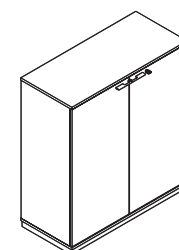

De besprekingstafels "Tornado"

Vierkant, rechthoekig, rond, ...



Besprekingstafels

AFMETINGEN	140x140		140x70		1/2 rond 140x70	
REF	TORTACA		TORTARC		TORTAAJ	
€	306		210		112	

Ronde besprekingstafels

AFMETINGEN	H113,5 - Ø80	H72 - Ø80	H72 - Ø80 op wieltjes
REF	TORTARD113	TORTARD72	TORTARO72
€	186	178	122



... of tonvormige besprekingstafels



Tonvormige besprekingstafels

AFMETINGEN	200x120/80	240x120/80	280x120/80	320x140/100	360x140/100	400x140/100
	4 poten	8 poten	8 poten	8 poten	8 poten	8 poten
Aantal pers.	6	8	8	10	10	12
REF	TORTATO200	TORTATO240	TORTATO280	TORTATO320	TORTATO360	TORTATO400
€	330	499	629	659	679	699

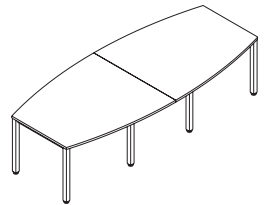

OPTIE | In de hoogte verstelbaar onderstel van 72 tot 84 cm | **5 € /per poot** | H

Horizontale sleuven



AFMETINGEN	59	79	99	119
REF	TORG060	TORG080	TORG100	TORG120
€	25	27	30	31

Verticale slurf

AFMETINGEN	77
REF	TORG077
€	40



Stekkerblokken

AFMETINGEN	221x84 mm	274x84 mm	327x84 mm	327x84 mm
	3 stekkers	3 stekkers en 2xRJ45	2 stekkers 2xRJ45 + VGA	2 stekkers 2xRJ45 + HDMI
REF	TOR3P	TOR2P1	TOR2P2	TOR2P3
€	149	329	599	649

Harmony



Dankzij het driehoekige onderstel legt het Harmony-gamma de nadruk op de verfijnde en elegante lijn, maar blijft het desondanks een eenvoudig designgamma.

D/G Moet worden vervangen door de keuze voor het soort bijzetbureau: D: rechts / G: links



Accessoires zie pagina 32

Rechte bladen

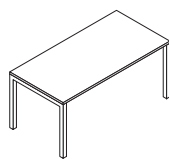
AFMETINGEN	160 x 80	180 x 80	200 x 80	200 x 100
REF	HAR168	HAR188	HAR208	HAR210
€	310	320	330	399







Uitbreidingen

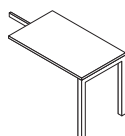

AFMETINGEN	80 x 40	160 x 60
		
REF	EX8040	EX1660
€	54	119

Bijzetbureau

AFMETINGEN	80 x 60	120 x 60
REF	HARR86D/G	HARR126D/G
€	169	190



KLEUREN BLADEN & HOUTEN LADEBLOKKEN				
	Wit	Medium esdoorn	Havanna	Wengé
	BC	EM	HA	NG

METAAL-KLEUREN		
	Wit	Aluminium
	BW	AL



Technische informatie

Werkblad

- Gemelamineerd blad met hoge weerstand dat voldoende tegengewicht vormt, dikte 25 mm dichtheid 725 kg/m³. E1-gecertificeerd.
- ABS-stootranden 2 mm.
- Metalen tussenstukken voor bevestiging onderstellen.

Onderstel

- Het driehoekige onderstel van het Harmony-gamma combineert robuustheid, veranderlijkheid, design en elegantie. Beschikbaar in wit of alu.
- De optionele verstelbare poot biedt een perfecte ergonomie.
- Manuele regeling van de hoogte van elk verlengstuk (72 tot 86 cm)



Structuur

- Metalen structuurbalk



HARRH1

OPTIE	In de hoogte verstelbare verlengstukken	50€ per 2	HARRH1
-------	---	------------------	--------

Gemelamineerde beenafscherming

AFMETINGEN	80	120	160	180
REF	VDF-80	VDF-120	VDF-160	VDF-180
€	40	46	59	64

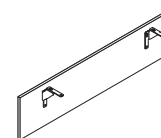

HARCO1

Mobiele console:
B120 x D60 x H60 cm

AFMETINGEN	3 deuren	2 deuren, 3 laden
REF	HARCO1	HARCO2
€	460	680

Houten ladeblokken met
dezelfde hoogte als
het bureau:
H72 x B43 cm

Houten mobiele ladeblokken: H60 x B43 cm

AFMETINGEN	3 laden + pennenlade P60	3 laden + pennenlade P80	1 lade voor papierwaren 1 penne-lade 1 lade voor hangmappen P60	1 lade voor papierwaren 1 penne-lade 1 lade voor hangmappen P80	4 laden + pennenlade P80	2 laden voor papierwaren 1 penne-lade 1 lade voor hangmappen P80
REF	HARCAM316	HARCAM318	HARCAM216	HARCAM218	HARCAH418	HARCAH318
€	228	245	222	235	305	290

Houten kasten

Bovenbladen metalen kasten

AFMETINGEN	80 x 45 x 77	80 x 45 x 184	80 x 45 x 184	80 x 45 x 184	80 x 43	100 x 43	120 x 43
Legplanken	1	4	4	4			
REF	RGAB7280	RGAH19890	RGAHV19890	RGAHSP19890	TOP8043	TOP10043	TOP12043
€	199	449	649	319	42	45	48

Accessoires

Scheidingschermen

Deze panelen stellen de operators in staat om in de beste omstandigheden te werken en werden speciaal voor de inrichting van bureaus ontworpen. Een goede afscheiding tussen de bureaus is de eerste en fundamentele vereiste voor operationele bureaus. Deze akoestische scheidingswanden verenigen de 3 aspecten die van cruciaal belang zijn voor een goede geluidsbalans: de geluidsabsorptie, de geluidsspreiding en de geluidsreductie.

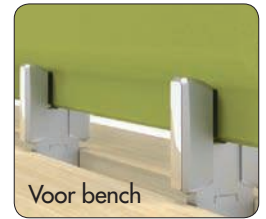
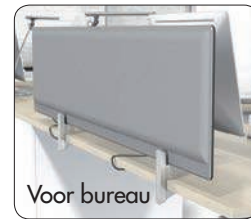

Scheidingswand

F/T	Versie met frontpaneel: F / Versie met dwarspaneel: T
-----	---

BESCHRIJVING	Gesatineerd wit melkplexiglas		Stoffen akoestische scheidingswand			
AFMETINGEN	120 x 35	160 x 35	80 x 39	120 x 39	140 x 39	160 x 39
voor individueel bureau						
REF	PE-12035VEF/T	PE-16035VEF/T	PEA-8039F/T	PEA-12039F/T	PEA-14039F/T	PEA-16039F/T
€	159	184	188	229	272	294
voor benchbureau						
REF	PEB-12035VEF/T	PEB-16035VEF/T	PEB-8039F/T	PEB-12039F/T	PEB-14039F/T	PEB-16039F/T
€	174	199	196	239	286	299

STOFKLEUREN LEVERINGSTERMIJN 4 WEKEN



(IA) Grijs



(IB) Ivoor



(IC) Rood



(ID) Geel



(IE) Groen



(IF) Blauw



Schermdrager

Deze telescopische arm biedt de mogelijkheid om het scherm gemakkelijk op de gewenste hoogte te plaatsen.

REF	ACBE1
€	259



MIKADO-configuratie met frontale + dwarse scheidingswand BENCH

Flex

Dankzij dit nuttige en goedkope systeem kunt u uw kabels onder uw bureau bevestigen. De 2 onderdelen kunnen samen of afzonderlijk worden gebruikt.

Het bovenste deel duwt de kabels tegen het blad, het onderste deel kan worden gebruikt als steun om de kabel- of stekkerbak te bevestigen. (B500 mm)

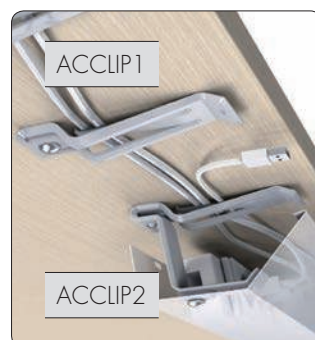

REF	ACCLIP1	ACCLIP2
€	3	29

Ledlamp op het voetstuk

Voltage :
100-240V
Verbruiksvermogen:
9.5W



REF	ACLAM1
€	174

Accessoires

T level

Dit profiel biedt de mogelijkheid om elk type bureau met een grote keuze aan accessoires uit te rusten. Het in alu vervaardigde systeem is beschikbaar in verschillende versies en lengtes. Verkrijgbaar voor individuele bureaus of bench. Dankzij de drager kunt u verschillende accessoires bevestigen: een lamp, een postbakje, scheidingschermen of een draagarm.







T Level

AFMETINGEN	B800	B1200	B1400	B1600
REF	ACTL800	ACTL1200	ACTL1400	ACTL1600
€	156	179	182	199



Accessoires T Level

BESCHRIJVING	Postbakje A4 metaal alu	Postbakje A4 met rek - metaal alu	Leveringsbakje	Arm voor scherm	Ledlamp met bevestiging
					
REF	ACBAC1	ACBAC2	ACBAC3	ACBE2	ACLAM2
€	26	58	26	229	188

Akoestische scheidingswand (kleuren te vermelden zie pagina 32)

AFMETINGEN	B770 x H390	B1170 x H390	B1370 x H390	B1570 x H390
REF	ACESTL770	ACESTL1170	ACESTL1370	ACESTL1570
€	143	180	217	250

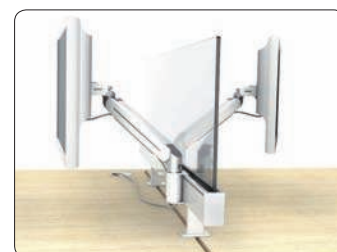

Drager centrale eenheid metaal alu



REF	ACUC
€	49

TOP ACCES ECO

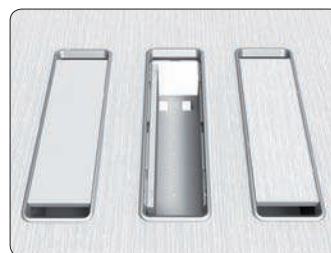

AFMETINGEN	L420 x D113
REF	ACTOPAC
€	60



"Flap"-sleuven

Dit innovatieve en gepatenteerde sleufstelsel biedt u de mogelijkheid om uw kabels horizontaal en verticaal op te bergen. Ontworpen voor de bevestiging aan het plafond of voor uw bureaus. "Flap" wordt gekenmerkt door zijn netheid en grote functionaliteit en biedt een gemakkelijke en directe toegang tot de kabels.

AFMETINGEN	Verticaal B650	Horizontaal B650	Horizontaal B1200
REF	ACFLAP1	ACFLAP2	ACFLAP3
€	29	29	36



Glamour



De lijn die het esthetische aspect en de soberheid van het kegelvormige onderstel verenigt met de functionaliteit van het systeem. Het draagframe zorgt voor de stabiliteit van de plaat. Het Glamour-gamma combineert de bureaus en vergadertafels voor een perfecte werkharmonie.



Bureaus

AFMETINGEN	180 x 80*	200 x 80*	200 x 100	220 x 100
REF	GLA188	GLA208	GLA210	GLA220
€	540	560	590	610

* Uit voorraad. Andere afmetingen met leveringstermijn van 4 weken.

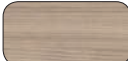

KLEUREN BLADEN & HOUTEN LADEBLOKKEN				
	Wit	Medium esdoorn	Havanna	Wengé
	BC	EM	HA	NG

METAAL-KLEUREN		
	Wit	Aluminium
	BW	AL



Technische informatie

Werkblad

- Gemelamineerd blad met hoge weerstand dat voldoende tegengewicht vormt, dikte 25 mm dichtheid 725 kg/m³. E1-gecertificeerd.
- ABS-stootranden 2 mm.
- Metalen tussenstukken voor bevestiging onderstellen.



Platen uit voorraad met afmetingen 180 x 80 cm en 200 x 80 cm
 Andere afmetingen: leveringstermijn 4 weken.

Onderstel

- Het kegelvormige onderstel is uitsluitend verchromd verkrijgbaar.
- Diameter: 60 mm
- Verchroomde verlengstukken van 25 mm met een grote steldop onderaan.

Structuur

- Metalen structuurbalk
- Draagframe

Vierkante en rechthoekige vergadertafels

AFMETINGEN	140x140
REF	GLA1414
€	659

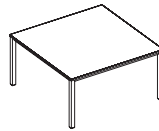

140x280	140x420
GLA1428	GLA1442
1349	1999

Tonvormige vergadertafels

AFMETINGEN	200x120/80	240x120/80
REF	GLATATO200	GLATATO240
€	689	839

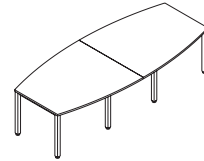

Houten ladeblokken met dezelfde hoogte als het bureau:
 H72 x B43 cm

Houten mobiele ladeblokken: H60 x L43cm

AFMETINGEN	3 laden + pennenlade P60	3 laden + pennenlade P80	1 lade voor papierwaren 1 pennenlade 1 lade voor hangmappen P60	1 lade voor papierwaren 1 pennenlade 1 lade voor hangmappen P80	4 laden + pennenlade P80	2 laden voor papierwaren 1 pennenlade 1 lade voor hangmappen P80
REF	GLACAM316	GLACAM318	GLACAM216	GLACAM218	GLACAH418	GLACAH318
€	228	245	222	235	305	290



GLACO2

Mobiele console:
 B120 x D60 x H60 cm

AFMETINGEN	3 deuren	2 deuren, 3 laden
REF	GLACO1	GLACO2
€	460	680

Houten kasten

Bovenbladen metalen kasten

AFMETINGEN	80 x 45 x 77	80 x 45 x 184	80 x 45 x 184	80 x 45 x 184	80 x 43	100 x 43	120 x 43
Legplanken	1	4	4	4			
REF	RGAB7280	RGAH19890	RGAHV19890	RGAHSP19890	TOP8043	TOP10043	TOP12043
€	199	449	649	319	42	45	48

Elégance (Leveringstermijn 15 dagen)

Elegantie en zuiverheid van lijnen, een manier om u te onderscheiden en uw verschil in de verf te zetten



Platen

- Dikte 40 mm in melamine met hoge weerstand
- Dichtheid 700 kg/m³ - E1-norm
- P4-kwaliteit, schitterende ABS-stootrand met dikte 3 mm
- Metalen afdeklad drager in staal doorsnede 35 x 25 mm

Onderstellen

- Buis met doorsnede 60 x 60 mm in staal dikte 20/10e
- Invoeging in chroom
- Epoxyverf
- Voorzien van steldoppen voor nivellering.

Bureaus hoogte 740 mm

BESCHRIJVING	AFMETINGEN	KLEUREN	€	REF
Bureau witte poten	B2000 x D1000 mm	Lichte eik	499	EL200CCB
		Wengé		EL200WEB
Bureau carbonpoten	B2000 x D1000 mm	Lichte eik	499	EL200CCA
		Wengé		EL200WEA
Bureau aluminium poten	B2000 x D1000 mm	Lichte eik	499	EL200CCU
		Wengé		EL200WEU
Bijzetbureau met witte poten	B1000 x D600 mm	Lichte eik	210	EL106CCB
		Wengé		EL106WEB
Bijzetbureau met carbonpoten	B1000 x D600 mm	Lichte eik	210	EL106CCA
		Wengé		EL106WEA
Bijzetbureau met aluminium poten	B1000 x D600 mm	Lichte eik	210	EL106CCU
		Wengé		EL106WEU

GARANTIE
5
Jaar

ECO-
ONTWERP

GEMELAMINEERDE KLEUREN	Lichte eik	Wengé
	CCC	WEW

OPTIES		€	REF
Doorschijnende beenaafscherming		116	ELMQ018AT3
Vierkante verchroomde kabeldoorgang*		10	ELMQ030CH5

* Plaatsing zonder boring dankzij vooraf doorgestoken plaatsysteem

Elégance (Leveringstermijn 15 dagen)

Bureau met bijbehorende bergruimte, kies de configuratie die bij u past



Mobiel ladeblok, gemonteerd geleverd, inclusief pennenlade

BESCHRIJVING	AFMETINGEN	KLEUREN	€	REF
Ladeblok met 2 laden waarvan 1 voor hangmappen	B430 x H560 x D600 mm	Lichte eik	229	EL532CCC
		Wengé		EL532WEW
Ladeblok met 3 platte laden	B430 x H560 x D600 mm	Lichte eik	229	EL533CCC
		Wengé		EL533WEW

EL532CCC



EL533CCC



Mobiele console met ladeblok, gemonteerd geleverd, kan zowel recht als links worden geplaatst, inclusief pennenlade

BESCHRIJVING	AFMETINGEN	KLEUREN <small>(+code van de afwerking vermelden na de referentie)</small>	€	REF
Console met 2 laden waarvan 1 voor hangmappen	H630 x B1200 x D600 mm	Zijkanten, onderkant en achterkant in het wit	460	EL232B + afw
		Zijkanten, onderkant en achterkant in alu		EL232U + afw
		Zijkanten, onderkant en achterkant in carbon		EL232A + afw
Console met 3 platte laden	H630 x B1200 x D600 mm	Zijkanten, onderkant en achterkant in het wit	460	EL233B + afw
		Zijkanten, onderkant en achterkant in alu		EL233U + afw
		Zijkanten, onderkant en achterkant in carbon		EL233A + afw

KLEUREN AFWERKING		
		Lichte eik CCC



EL232UCCC



EL233UCCC

Prestige (Leveringstermijn 15 dagen)

Een sobere en elegante lijn die hout en staal verenigt.
Bureau met bijzetbureau.



Onderstel

- Dikte 40 mm in melamine met hoge weerstand
- Dichtheid 700 kg/m³ - E1-norm
- P4-kwaliteit. Schitterende ABS-stootrand met dikte 3 mm

Platen

- Dikte 25 mm in melamine met hoge weerstand
- Dichtheid 700 kg/m³ - E1-norm
- P4-kwaliteit, schitterende ABS-stootrand met dikte 3 mm
- Stalen verbindingscarter van 20/10e, bekleed met blinkende aluminium epoxyverf

Structure

- Structuur met 2 metalen balken waarvan 1 elektrificeerbaar
- Bureaus hoogte 740 mm

GEMELAMINEERDE KLEUREN		
	Lichte eik	Wengé
	CCC	WEW

BESCHRIJVING	AFMETINGEN	KLEUREN	€	REF
Bureau	B2000 x D1000 mm	Lichte eik	799	PR200CC
		Wengé		PR200WE
Bijzetbureau	B1000 x D600 mm	Lichte eik	459	PR160CC
		Wengé		PR160WE



OPTIES		€	REF
	Ronde alu kabeldoorgang*	6€	PRMQ001AL5
	Vierkante alu kabeldoorgang*	6€	PRMQ030AL5

* Plaatsing zonder boring dankzij vooraf doorgestoken plaatsysteem



Mobiel ladeblok, gemonteerd geleverd, inclusief pennenlade

BESCHRIJVING	AFMETINGEN	KLEUREN	€	REF
Ladeblok met 2 laden waarvan 1 voor hangmappen	B430 x H560 x D600 mm	Lichte eik	229	PR532CCC
		Wengé		PR532WEW
Ladeblok met 3 platte laden	B430 x H560 x D600 mm	Lichte eik	229	PR533CCC
		Wengé		PR533WEW

PR532CCC

PR533CCC



Prestige (Leveringstermijn 15 dagen)

Bureau op console



Console met laden met grote opbergcapaciteit binnen handbereik



Console met vakken rechts



Verborgen deur voor discreet opbergen of minibar (niet meegeleverd)

Bureau B2000 x D1000 mm op bijzetbureau B2000 x D600 met vakken

BESCHRIJVING	KLEUREN	€	REF
Console rechts	Lichte eik	1329	PR224CC
	Wengé		PR224WE
Console links	Lichte eik	1329	PR225CC
	Wengé		PR225WE
OPTIE : 1 DEUR VOOR ONDERSTE VAK	Lichte eik	38	PR222CC
	Wengé		PR222WE

Bureau B2000 x D1000 mm op bijzetbureau B2000 x D600 met laden

BESCHRIJVING	KLEUREN	€	REF
Console rechts	Lichte eik	1499	PR234CC
	Wengé		PR234WE
Console links	Lichte eik	1499	PR235CC
	Wengé		PR235WE
OPTIE: 2 platte laden in plaats van lade voor hangmappen	Lichte eik	52	PR444CC
	Wengé		PR444WE
OPTIE: Pennenlade als lade		8	MQABU001TG



Opbergmeubelen "Quadra"

(Leveringstermijn 15 dagen)

Een efficiënte en kwalitatief hoogstaande organisatie.
Praktische opbergmeubelen, gemakkelijk te gebruiken in het
dagelijkse werkleven, een harmonieuze aanvulling op onze
Elégance-lijn voor bureaus ...



QUA160CC
299 €

GARANTIE
5
jaar

GEMELAMINEERDE KLEUREN		
	Lichte eik CCC	Wengé WEW

BESCHRIJVING	AFMETINGEN	KLEUREN	€	REF
Opbergmeubel met 16 vakken	B1600 x H1630 x D300 mm	Lichte eik	299	QUA160CC
		Wengé		QUA160WE



Opbergmeubelen "Quadra"

(Leveringstermijn 15 dagen)

... of "Prestige"

QUA084WE
149€

GEMELAMINEERDE
KLEUREN



Lichte eik

CCC



Wengé

WEW



BESCHRIJVING	AFMETINGEN	KLEUREN	€	REF
Opbergmeubel met 6 vakken	B1210 x H840 x D300 mm	Lichte eik	149	QUA084CC
		Wengé		QUA084WE



Kasten "Linea" (Leveringstermijn 15 dagen)

De perfecte aanvulling op uw bureau-inrichting van het Prestige- of Elégance-gamma. Kwaliteitskasten met een aantal sterke punten:



Binnenkant



Bovenkant



Poten



Achterkant kast



Slot



BESCHRIJVING	AFMETINGEN	KLEUREN BEHUIZING	KLEUREN DEUREN	€	REF
Hoge kast 2 deuren 3 verstelbare houten legplanken + 1 halfvaste	B800 x H1800 x D470	Parelwit	Lichte eik	449	L1880CG
		Aluminium			L1880CU
		Antraciet			L1880CA
		Parelwit	Wengé	449	L1880WG
		Aluminium			L1880WU
		Antraciet			L1880WA

BESCHRIJVING	AFMETINGEN	KLEUREN BEHUIZING	KLEUREN DEUREN	€	REF
Middelhoge kast 2 verstelbare houten legplanken	B800 x H1020 x D470	Parelwit	Lichte eik	359	L1810CG
		Aluminium			L1810CU
		Antraciet			L1810CA
		Parelwit	Wengé	359	L1810WG
		Aluminium			L1810WU
		Antraciet			L1810WA



 Classeur
 Hangmappen

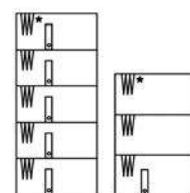

H1800 mm H1020 mm

GARANTIE
5
jaar

GEMELAMINEERDE
KLEUREN

	
Lichte eik	Wengé
CCC	WEW

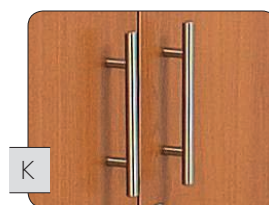

K

OPTIE	Handgrepen	8€	K-handgrepen
-------	------------	-----------	--------------

Vergadertafels "ECLIPSE"

(Leveringstermijn 15 dagen)

Ovale tafels met verfijnde lijnen en ideale afmetingen



GARANTIE
5
jaar

BESCHRIJVING	AFMETINGEN	VOET	€	REF
Modulaire ovale tafel voor 10 tot 12 personen	B2800 x D1400 mm	Kruis	429	EC280C + afw.
		Elégance	499	EC280E + afw.

BESCHRIJVING	AFMETINGEN	VOET	€	REF
Uitbreiding voor modulaire tafels + 4 tot 6 personen	B1400 x D1400 mm	Kruis	249	EC980C + afw..
		Elégance	260	EC980E + afw..

Afwerking poten
(code vermelden na de referentie)

Poten in kruisvorm	CCC	WEW
Elégance-poten (wit)	CCB	WEB
Elégance-poten (aluminium)	CCU	WEU
Elégance-poten (antraciet)	CCA	WEA



Lichte eik Wengé



MEA 1980

MEA 1980
399€

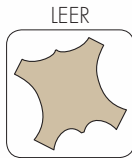

- Leren stoel met hoge rugleuning en met polyurethaan bedekte hoofdsteun en armlenningen
- Mechanisme voor kantelen en verschuiven
- Helling instelbaar in 5 posities
- Veiligheidssysteem tegen terugkeren van de rugleuning
- Onderstel in gepolijst aluminium met 5 poten en nylon wieltjes
- Regelbare veerkracht naargelang het gewicht van de gebruiker

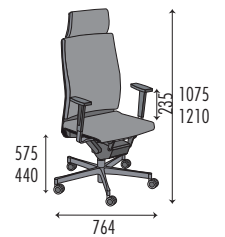

BESCHIKBARE KLEUR

Zwart leer (NR)

KANTELEN EN
VERSCHUIVEN



GARANTIE
5
jaar

EN 1335 1-2-3

OPTIE | Wielletjes voor harde ondergrond | **10€** | MEARSD3

Padova

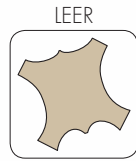

MEA PADOVAHDC
529€

- Leren stoel met hoge rugleuning en in de hoogte verstelbare lendensteun
- Synchroon blokkeringsmechanisme met 4 posities met anti-panieksysteem
- In de hoogte verstelbare zitting met beschermingsschelp
- Vaste leren armleuningen in gepolijst aluminium
- Onderstel in gepolijst aluminium met 5 poten en nylon wieltjes



BIFMA
ANSI/BIFMA X5-2002

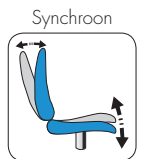

OPTIE | Wielletjes voor harde ondergrond | **10€** | MEARSD3

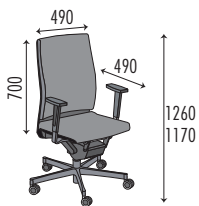

BESCHIKBARE KLEUR



Zwart leer (NR)

Padova bezoeker

MEA PADOVABDC
339€

- Zwarte leren rugleuning met in de hoogte verstelbare lendensteun
- Zwarte leren zitting
- Verchromde metalen sledeconstructuur

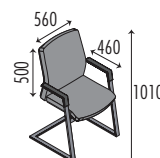

MEA 1740

MEA 1740
399€

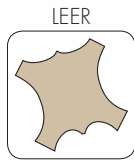

- Leren stoel met middelhoge rugleuning en met polyurethaan bedekte houten armleuningen
- Mechanisme voor kantelen en verschuiven
- Helling instelbaar in 5 posities
- Veiligheidssysteem tegen terugkeren van de rugleuning
- Regelbare veerkracht naargelang het gewicht van de gebruiker
- Onderstel in gepolijst aluminium met 5 poten en nylon wieltjes

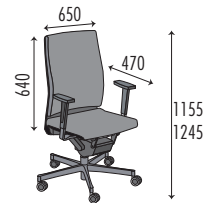

BESCHIKBARE KLEUR



Zwart leer (NR)

KANTELEN EN
VERSCHUIVEN



GARANTIE

5
jaar

EN 1335 1-2-3

OPTIE

Wieltjes voor harde ondergrond

10€

MEARSD3

Palerma

MEA PALERMA HD

429€

LEER



- Leren stoel met hoge rugleuning en verstelbare hoogte
- Gedecentreerd synchroon blokkeringsmechanisme in 5 posities met antipaniëksysteem
- Beweegbare armleuningen in grijze aluminium afwerking
- Regelbare veerkracht
- Aluminium onderstel met 5 poten met wieltjes

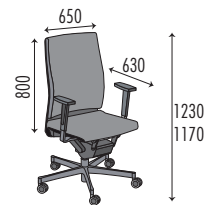

Synchroon

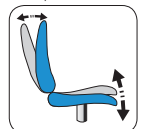

GARANTIE

5
jaar



BIFMA

ANSI/BIFMA X5.-2002



BESCHIKBARE KLEUR

Zwart leer (NR)

OPTIE | Wielletjes voor harde ondergrond | **10€** | MEARSD3

MEA 1860

MEA 1860
399€

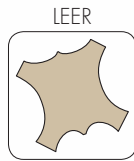

- Hoge rugleuning en geïntegreerde hoofdsteun
- Comfortabele rondingen op de zitting en in de rugleuning van hogedichtheidsschuim
- Zitting en rugleuning in leer
- Zeer performant synchromechanisme met persoonlijke regeling van de veerkracht
- Blokkeringsmechanisme in 5 posities, veiligheidssysteem tegen terugkeren
- Verstelbaar lendenmechanisme
- Verschuifbare zitting
- Onderstel met 5 poten in zwart gewapend nylon



VERSCHUIFBARE ZITTING



Synchroon

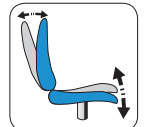

GARANTIE
5
jaar

EN 1335 1-2-3



BESCHIKBARE KLEUR

Zwart leer (NR)

OPTIES			
	Wieltjes voor harde ondergrond	10€	MEARSD3
	In de hoogte verstelbare armlenningen	35€	MEAR20N
	Onderstel in gepolijst aluminium	40€	MEAST36CR
	Onderstel in gepolijst epoxyaluminium	40€	MEAST36ALU

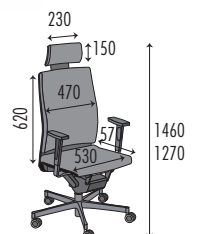

MEA 940



SPLITLEER

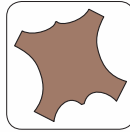

MEA 940

229€

- Onderstel met 5 poten in zwart gewapend nylon
- Centraal kantelsysteem, veerkracht regelbaar en blokkeerbaar
- Interne structuur van de zitting en de rugleuning in gelaagd beukenhout

KANTELEN



GARANTIE

5
jaar

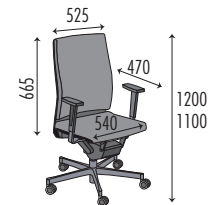

EN 1335 1-2-3

OPTIE	Wieltjes voor harde ondergrond	10€	MEARSD3
-------	--------------------------------	------------	---------



BESCHIKBARE KLEUR

Zwart leer (NR)

MEA 920



- Onderstel in verchromd staal
- Niet-ontvlambaar zwart imitatieleer

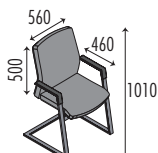

BESCHIKBARE KLEUR



Zwart (SKN)

MEA 920

99€

MEA 1040



MEA1040
194€

SPLITLEER

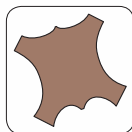

- Interne structuur van de zitting en de rugleuning in gelaagd beukenhout
- Centraal kantelsysteem, veerkracht regelbaar en blokkeerbaar
- Onderstel met 5 poten in zwart gewapend nylon

KANTELEN

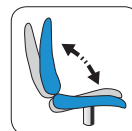

GARANTIE

5
jaar

EN 1335 1-2-3

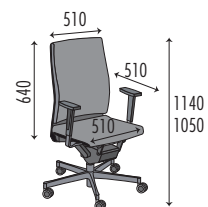

OPTIE | Wieltjes voor harde ondergrond | **10€** | MEARSD3



BESCHIKBARE KLEUR

Zwart leer (NR)

MEA 740



MEA 740
204€



- Zitting en rugleuning in zwart splitleer van uitstekende kwaliteit (kalfsleer)
- Interne structuur in gelaagd beukenhout
- Onderstel met 5 poten in zwart gewapend nylon
- Centraal kantelsysteem, veerkracht regelbaar en blokkeerbaar
- ArMLEUNINGEN in zwart polyurethaan

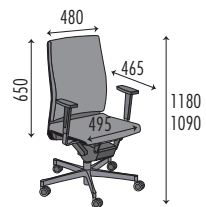

OPTIE | Wieltjes voor harde ondergrond | **10€** | MEARSD3

BESCHIKBARE KLEUR

Zwart leer (NR)

Monaco

- Stoel met hoge rugleuning met zwarte structuur
- Netwaving zwarte 3D-hoofdsteun, verstelbaar in hoogte en hoek
- Niet-ontvlambare, in hoek en hoogte verstelbare transparante zwarte rugleuning met lendensteun
- Niet-ontvlambare, in de hoogte verstelbare en verschuifbare netwaving zwarte zitting
- 4D-armleuningen
- Synchron mechanisme met 4 posities
- Onderstel in gepolijst aluminium met 5 wielotjes in polyurethaan

MEA MONACO HD

659€





VERSCHUIFBARE
ZITTING

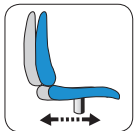

Synchroon

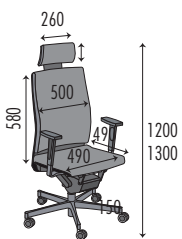
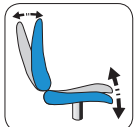

BIFMA
ANSI/BIFMA X5.-2002

EN 1335 1-2-3

GARANTIE
5
jaarr

BESCHIKBARE KLEUR



Zwart (NR)

Vegas

MEA VEGAS MDAL

499€

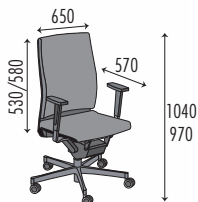

- Stoel met hoge rugleuning en niet-ontvlambare, in de hoogte verstelbare en verschuifbare, zwarte stoffen zitting
- In de hoogte verstelbare netwaving zwarte rugleuning met lendensteun
- 4D-armleuningen
- Synchroon blokkeringsmechanisme met 5 posities
- Gepolijst aluminium onderstel met 5 wieltjes in polyurethaan



VERSCHUIFBARE ZITTING

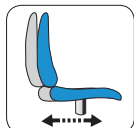

Synchroon

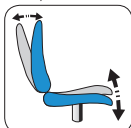

GARANTIE

5
jaar

EN 1335 1-2-3



BIFMA

ANSI/BIFMA X5.-2002

BESCHIKBARE KLEUR

Zwart (NR)



OPTIE | Wieltjes voor harde ondergrond **10€** | MEARSD3

Vegas Noir

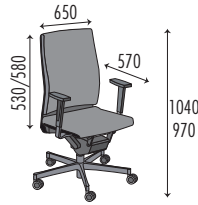

MEA VEGAS MDN

364€

- Stoel met hoge rugleuning met of zonder in de hoogte en helling verstelbare hoofdsteun
- Niet-ontvlambare, in de hoogte verstelbare en verschuifbare stoffen zwarte zitting
- In de hoogte verstelbare netwaving zwarte rugleuning met lendensteun
- 3D-armleuningen
- Synchroon blokkeringsmechanisme met 5 posities
- Nylon onderstel met 5 wieltjes in polyurethaan



MEA VEGAS HDN

414€

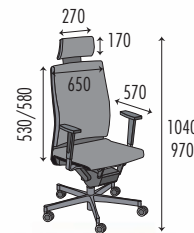

VERSCHUIFBARE ZITTING

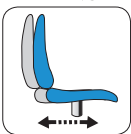

Synchroon

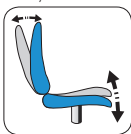

GARANTIE

5
jaar

EN 1335 1-2-3



BIFMA

ANSI/BIFMA X5.-2002

OPTIE Wieltjes voor harde ondergrond **10€** MEARSD3

BESCHIKBARE KLEUR

Zwart (NR)



Mirage

MEA MIRAGE HDAL
379€

- In de hoogte en hoek verstelbare transparante nylon hoofdsteun
- Niet-ontvlambare netwaving nylon rugleuning met in de hoogte verstelbare lendensteun
- Niet-ontvlambare, in de hoogte verstelbare en verschuifbare, transparante nylon zitting
- In de hoogte verstelbare armleuningen met opvulling in polyurethaan
- Synchroon mechanisme met 5 posities
- Nylon onderstel, uitgerust met 5 wieltjes in polyurethaan



VERSCHUIFBARE
 ZITTING

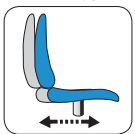

Synchroon

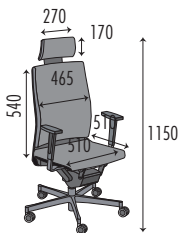
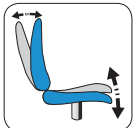

BESCHIKBARE KLEUR



Zwart (NR)

OPTIE | Wieltjes voor harde ondergrond **10€** | MEARSD3

GARANTIE

5
jaar

EN 1335 1-2-3

BIFMA

ANSI/BIFMA X5.-2002

Napoli

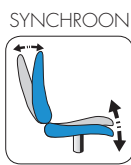
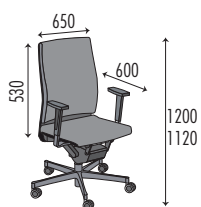

MEA NAPOLI MD
269€

- Stoel met middelhoge rugleuning met of zonder hoofdsteen, in de hoogte verstelbaar met stoffen zitting
- Netwaving zwarte rugleuning met in de hoogte en diepte verstelbare lendensteun
- In de hoogte verstelbare en draaiende 2D-armleuningen
- Gedecentreerd synchroon blokkeringsmechanisme met 5 posities
- Zwart nylon onderstel met 5 wieltjes in polyurethaan



MEA NAPOLI HD
319€

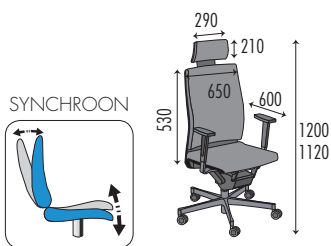

BESCHIKBARE KLEUR

Zwart (NR)

GARANTIE
5
jaar

BIFMA
ANSI/BIFMA X5.-2002

OPTIE | Wielletjes voor harde ondergrond **10€** | MEARSD3

Lucca

MEA LUCCA

319€



- Stoel met hoge rugleuning
- Netwaving zwarte 3D-hoofdsteun, verstelbaar in hoogte en hoek
- Niet-ontvlambare, in de hoogte verstelbare zwarte stoffen zitting
- Synchroon blokkeringsmechanisme met 4 posities
- Verschuifbare zitting
- Niet-ontvlambare transparante zwarte rugleuning met in de hoogte verstelbare lendensteun
- Automatische regeling van de veerkracht in functie van het gewicht van de gebruiker
- 4D-armleuningen in polyurethaan
- Nylon onderstel, uitgerust met 5 wieltjes in polyurethaan



VERSCHUIFBARE
ZITTING

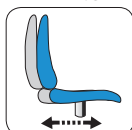

SYNCHROON

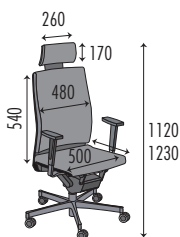
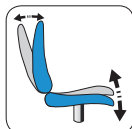

BESCHIKBARE KLEUR

Zwart (NR)



BIFMA

ANSI/BIFMA X5.-2002

OPTIE | Wieltjes voor harde ondergrond **10€** | MEARSD3

MEA 560

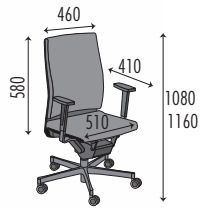

MEA 560
269€

- Stoel met zwarte netwaving hoge rugleuning
- Synchroon mechanisme met persoonlijke regeling van de veerkracht en blokkering in 5 posities
- Rugleuning via "up-down"-systeem in de hoogte verstelbaar, veiligheidssysteem tegen terugkeren van de rugleuning
- Onderstel met 5 poten in zwart gewapend nylon
- Verschuifbare zitting
- Niet-ontvlambare stoffen zitting M1



MEA 560 BW
359€

VERSCHUIFBARE ZITTING



SYNCHRONE



EN 1335 1-2-3

GARANTIE
5
jaar

MEAA08



OPTIES	2D-armleuningen	40€	MEAA08
	3D-armleuningen	50€	MEAA12
	Wieljes voor harde ondergrond	10€	MEARSD3
	Onderstel in gepolijst aluminium	40€	MEAST36CR
	Versterkte beklede hoofdsteun	50€	MEAHT + CODE STOF

BESCHIKBARE KLEUR



LEVERINGSTERMIJN KLEUREN 4 WEKEN

Andere keuzes voor Xtreme-stoffen zie kleurstalen pagina 88

Atena

MEA ATENA MD

219€



- Stoel met middelhoge rugleuning en niet-ontvlambare, in de hoogte verstelbare zwarte stoffen zitting
- Synchroon blokkeringsmechanisme met 4 posities
- Niet-ontvlambare netwaving zwarte rugleuning met lendensteun
- Regelbare veerkracht
- Zwart nylon onderstel met 5 nylon wieltjes
- In de hoogte en diepte verstelbare 2D-armleuningen



SYNCHROON

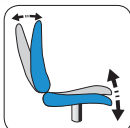

GARANTIE

3
jaar

EN 1335 1-2-3

BIFMA

ANSI/BIFMA X5.2002

BESCHIKBARE KLEUR



Zwart (NR)



OPTIE

Wieltjes voor harde ondergrond

10€

MEARSD3

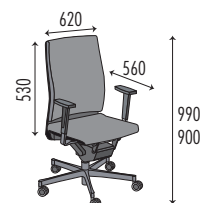

Modena

MEA MODENA MD

199€

- Stoel met middelhoge zwarte stoffen rugleuning
- Niet-ontvlambare, in de hoogte verstelbare zwarte stoffen zitting
- Niet-ontvlambare zwarte stoffen rugleuning
- In de hoogte en diepte verstelbare 2D-armleuningen
- Synchroon blokkeringsmechanisme met 4 posities
- Nylon onderstel met 5 nylon wieltjes



SYNCHROON



GARANTIE

3
jaar

EN 1335 1-2-3

BESCHIKBARE KLEUR



Zwart (NR)

OPTIE | Wieljes voor harde ondergrond | **10€** | MEARSD3

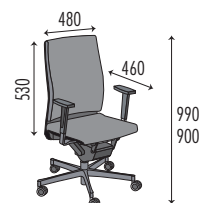

MEA 880

Versie in leer

MEA 880

569€

MEA 890

Versie 24u

MEA 890

469€



- Directiestoel voor intensief gebruik 24u
- Garantie tot 130 kg belasting
- Heel hoge rugleuning met ergonomische vormen
- Speciale stof 24u voor intensief gebruik
- Synchroon blokkeringsmechanisme met meerdere posities met antipaniekstelsysteem
- In de hoogte verstelbare armleuningen
- Onderstel met 5 poten in gepolijst aluminium met wieltjes

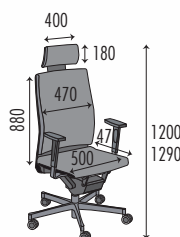

SYNCHROON

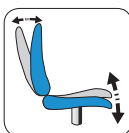

GARANTIE
3
jaar

EN 1335 1-2-3

OPTIE | Wieltjes voor harde ondergrond | **10€** | MEARSD3

BESCHIKBARE KLEUREN		
	Zwart leer (NR) NR	Zwart XR 009

LEVERINGSTERMIJN KLEUREN 4 WEKEN | Andere keuzes voor Xtreme-stoffen zie kleurstalen pagina 88

MEA 680



MEA 680
434€

- Rugleuning met of zonder hoofdsteen
- Synchroon mechanisme met gepersonaliseerde regeling van de veerkracht en blokkering in 6 posities
- Verschuifbare zitting
- 3D armleuningen
- Veerkracht regelbaar naargelang het gewicht van de gebruiker
- Veiligheidssysteem tegen terugkeren van de rugleuning
- Niet-ontvlambare stoffen bekleding M1
- Onderstel met 5 poten in zwart gewapend nylon

MEA 640



MEA 640
399€

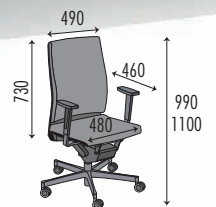
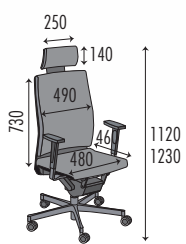

GARANTIE
5
jaar

EN 1335 1-2-3

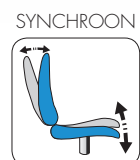

LEVERINGSTERMIJN KLEUREN 4 WEKEN | Andere keuzes voor Xtreme-stoffen zie kleurstalen pagina 88

MEA 580

(Leveringstermijn 4 weken)



MEA 580 NZ
399 €



MEA 580 BW
439 €

- Synchroon mechanisme met gepersonaliseerde regeling van de veerkracht en blokkering in 5 posities
- Rugleuning in de hoogte verstelbaar via "up-down"-systeem
- Verschuifbare zitting
- Veiligheidssysteem tegen terugkeren van de rugleuning
- Zitting volledig bekleed, alsook bovenste deel van de achterkant van de rugleuning
- In de hoogte verstelbare arMLEUNINGEN in polyurethaan
- Onderstel met 5 poten in zwart of wit gewapend nylon
- Niet-ontvlambare stoffen bekleding M1
- Bestaat ook in versie met wit onderstel, witte arMLEUNINGEN en witte achterkant van de rugleuning



VERSCHUIFBARE
ZITTING

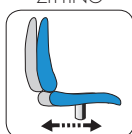

SYNCHROON

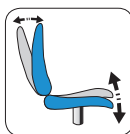

GARANTIE
5
jaar

EN 1335 1-2-3

BESCHIKBARE
KLEUR

	Zwart
	XR 009

LEVERINGSTERMIJN KLEUREN 4 WEKEN

Andere keuzes voor Xtreme-stoffen zie kleurstalen pagina 88

MEA 540

MEA 540
295 €



- Synchron verschuifstelsysteem met permanent contact
- Rugleuning in de hoogte verstelbaar via "up-down"-systeem
- Onderstel met 5 poten in zwart gewapend nylon
- Blokkeerbaar in 5 posities
- Veiligheidssysteem tegen terugkeren van de rugleuning
- Verschuifbare zitting
- Niet-ontvlambare stoffen bekleding M1



VERSCHUIFBARE ZITTING

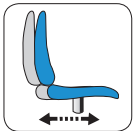

SYNCHROON

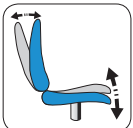

GARANTIE
3
jaar

EN 1335 1-2-3



MEAAR12

OPTIES	2D-armleuningen	40 €	MEAR08
	3D-armleuningen	50 €	MEAR12
	Wielotjes voor harde ondergrond	10 €	MEARSD3
	Onderstel in gepolijst aluminium	40 €	MEAST38CR



BESCHIKBARE KLEUR
Zwart
XR 009

LEVERINGSTERMIJN KLEUREN 4 WEKEN

Andere keuzes voor Xtreme-stoffen zie kleurstalen pagina 88

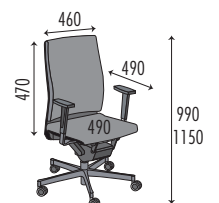

MEA 480

MEA 480
299€



- Synchron verschuifstelsysteem met permanent contact
- Volledig beklede zitting en rugleuning, uitgerust met in de hoogte verstelbare armleuningen in polyurethaanschuim
- Onderstel met 5 poten in zwart gewapend nylon
- Blokkeerbaar in 5 posities
- Veerkracht regelbaar naargelang het gewicht van de gebruiker
- Veiligheidssysteem tegen terugkeren van de rugleuning
- Verschuifbare zitting
- Niet-ontvlambare stoffen bekleding M1



VERSCHUIFBARE ZITTING

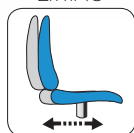

SYNCHROON

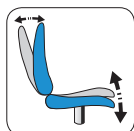

GARANTIE
5
jaar

EN 1335 1-2-3

OPTIES			
	Wieljes voor harde ondergrond	10€	MEARSD3
	Onderstel in gepolijst epoxyaluminium	40€	MEAST36ALU
	Onderstel in gepolijst aluminium	40€	MEAST36CR

BESCHIKBARE KLEUREN	Zwart	Blauw	Rood
	XR 009	XR 026	XR 079

LEVERINGSTERMIJN
KLEUREN 4 WEKEN

Andere keuzes voor Xtreme-stoffen zie kleurstenen pagina 88

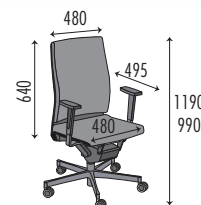

MEA 440

MEA 440
249€



- Synchron mechanisme met gepersonaliseerde regeling van de veerkracht en blokkering in 5 posities
- Rugleuning via "up-down"-systeem in de hoogte verstelbaar, veiligheidssysteem tegen terugkeren van de rugleuning
- Onderstel met 5 poten in zwart gewapend nylon
- Volledig beklede zitting
- Verschuifbare zitting
- Niet-ontvlambare stoffen bekleding M1



VERSCHUIFBARE ZITTING

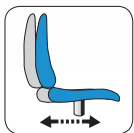

SYNCHROON

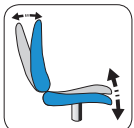

GARANTIE

5
jaar

EN 1335 1-2-3

OPTIES			
In de hoogte en breedte verstelbare en verschuifbare 3D-armleuningen	60€	MEAR15K	
Wieljes voor harde ondergrond	10€	MEARSD3	
Onderstel in gepolijst epoxyaluminium	40€	MEAST36ALU	
Onderstel in gepolijst aluminium	40€	MEAST36CR	

BESCHIKBARE KLEUREN	Zwart	Blauw	Rood
	XR 009	XR 026	XR 079

LEVERINGSTERMIJN
KLEUREN 4 WEKEN

Andere keuzes voor Xtreme-stoffen zie kleurstalen pagina 88

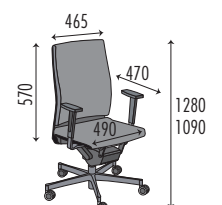

MEA 390



MEA 390
199€

- Stoel met Synchroon hoge rugleuning, in de hoogte verstelbare rugleuning
- Gesynchroniseerde beweging van de zitting en de rugleuning
- In 4 posities blokkeerbare rugleuning
- Regeling van de veerkracht van de rugleuning in functie van het gewicht van de gebruiker
- Veiligheidsfunctie tegen terugkeren van de rugleuning
- Niet-ontvlambare stoffen bekleding M1
- Onderstel met 5 poten in zwart gepapend nylon



SYNCHROON

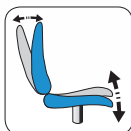

BESCHIKBARE KLEUREN		
	Zwart XR 009	Blauw XR 026

LEVERINGSTERMIJN KLEUREN 4 WEKEN | Andere keuzes voor Xtreme-stoffen zie kleurstalen pagina 88

GARANTIE
5
jaar

EN 1335 1-2-3

OPTIES	Versterkte beklede hoofdsteun	25€	MEAHRU + CODE STOF
	In de hoogte verstelbare armleuningen	35€	MEAR20N
	Wieltjes voor harde ondergrond	10€	MEARSD3
	Onderstel in gepolijst epoxyaluminium	40€	MEAST36ALU
	Onderstel in gepolijst aluminium	40€	MEAST36CR

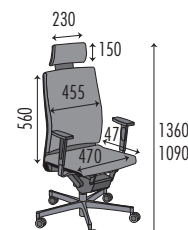

MEA 370



MEA 370
179€

- Stoel met Synchroon middelhoge in de hoogte verstelbare rugleuning
- In 4 posities blokkeerbare rugleuning
- Regeling van de veerkracht van de rugleuning in functie van het gewicht van de gebruiker
- Veiligheidsfunctie tegen terugkeren van de rugleuning
- Niet-ontvlambare stoffen bekleding M1
- Onderstel met 5 poten in zwart gewapend nylon



SYNCHROON

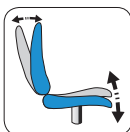

BESCHIKBARE KLEUREN	Zwart	Blauw	Rood
	XR 009	XR 026	XR 079

LEVERINGSTERMIJN KLEUREN 4 WEKEN
Andere keuzes voor Xtreme-stoffen zie kleurstaten pagina 88

GARANTIE
5
jaar

OPTIES			
Onderstel in gepolijst aluminium	40€	MEAST36CR	
Onderstel in gepolijst epoxyaluminium	40€	MEAST36ALU	
In de hoogte verstelbare armleuningen	35€	MEAR20N	
Wieltjes voor harde ondergrond	10€	MEARSD3	

EN 1335 1-2-3

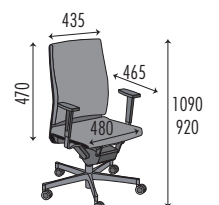

MEA 170

MEA170
149€



- Synchroon systeem, blokkeerbaar in 4 posities
- Veerkracht regelbaar in functie van het gewicht van de gebruiker
- Veiligheidssysteem tegen terugkeren van de rugleuning
- In de hoogte verstelbare rugleuning in verschillende posities met heugel
- Opgevulde zitting en rugleuning met een interne structuur in hout
- Onderstel met 5 poten in zwart gewapend nylon



SYNCHROON

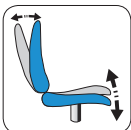

MEA170AR

GARANTIE
5
jaar

OPTIONS	In de hoogte verstelbare armleuningen	50€	MEA170AR
	Wielotjes voor harde ondergrond	10€	MEARSD3

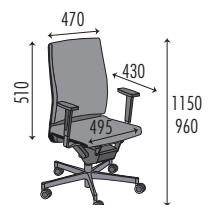

EN 1335 1-2-3

BESCHIKBARE KLEUREN		
	Antraciet C38	Blauw C06

LEVERINGSTERMIJN KLEUREN 4 WEKEN | Andere keuzes voor Xtreme-stoffen zie kleurstalen pagina 88

MEA 130



MEA130
99€

- Meer comfort dankzij de lendensteun en de dikke vulling van de zitting en rugleuning
- Systeem van permanent contact, in meerdere posities blokkeerbare rugleuning
- In de diepte en hoogte verstelbare rugleuning
- In de hoogte verstelbare zitting
- Onderstel met 5 poten in zwart nylon onderstel

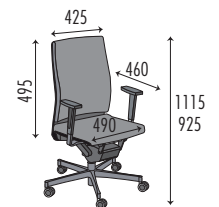

PERMANENT CONTACT

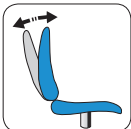

GARANTIE
3
jaar

EN 1335 1-2-3

OPTIES	Vaste armleuningen	30€	MEA130AF
	Wielotjes voor harde ondergrond	10€	MEARSD3



MEA130AF

BESCHIKBARE KLEUREN				
	Zwart C11	Blauw C06	Rood C02	Imitatieleer SKN

LEVERINGSTERMIJN
KLEUREN 4 WEKEN

Andere keuzes voor Xtreme-stoffen zie kleurstaten pagina 88

Vigo

BIFMA

ANSI/BIFMA X5.-2002

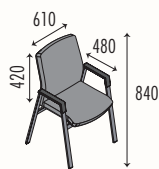

GARANTIE
5
jaar

MEA VIGO
179€



- Bezoekersstoel met 4 poten
- Zwarte transparante rugleuning met riepsysteem
- Opklapbare zwarte stoffen zitting
- Bewegbare ABS-armleuningen
- Metalen structuur met 4 poten in grijze aluminium afwerking
- Uitgerust met 2 half-ingeboorde wieltjes aan de zijkant van de poten voor gemakkelijk transport



BESCHIKBARE KLEUR



Zwart (NR)



OPTIES	Opklapbaar en verwijderbaar ABS-schrijftafeltje, met geïntegreerde drinkbeker en potloodhouder	50€	MEAVIGOTAB
	Bevestigingen	5€	MEAVIGORCD

Snoop



MEA SNOOP ACC

62€

- Bezoekersstoel met zwarte netwaving rugleuning
- Zwarte stoffen zitting
- Verchroomde metalen structuur
- Armleuningen in polypropyleen
- Stapelbaar per 10 stuks

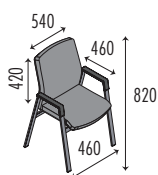
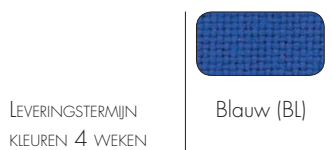

MEA 225

MEA 225

49€



- Rugleuning in netwaving, kader in gestroomlijnd nylon
- Zitting met dubbele dikte
- Onderstel met 4 poten in zwart epoxygelakt met antislipdoppen
- Interne structuur in gelaagd beukenhout
- Niet-ontvlambare stoffen bekleding M1
- Stapelbaar per 12 stuks



GARANTIE
5
jaar

EN 13761

BESCHIKBARE
KLEUREN

	
Zwart	Blauw
XR 009	XR 026

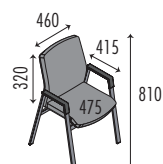

LEVERINGSTERMIJN KLEUREN 4 WEKEN

Andere keuzes voor Xtreme-stoffen zie kleurstalen pagina 88

MEA 220

Tot 12 stuks
stapelbaar

Interne structuur in
beuk multiplex



MEA 220C

30 €

MEA 220XR/SKN

38 €

- Goed gevulde zitting
- Acrylstof of niet-ontvlambare stoffen bekleding M1
- Onderstel met 4 poten uit zwart epoxymetaal met antisliddoppen
- Volledige helling van het achterste gedeelte van de zitting en rugleuning

MEA 220BH

59 €



- Identieke stoel als model MEA 220 in natuurlijke afwerking in beukenhout
- Verchromd buisvormig onderstel

MEAB220

MEAAT220

MEAAL220



OPTIES			
	Armleuningen	25 €	MEAB220
	Schrijftafeltje (DX) rechtshandigen (LX) linkshandigen	30 €	MEAAT220
	Verbindingsstuk	5 €	MEAAL220
	Onderstel geverchromd	8 €	MEAPCH220

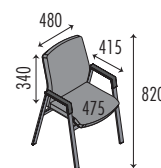

BESCHIKBARE KLEUREN				MEA 220C 30 €	GARANTIE 3 jaar	LEVERINGSTERMIJN KLEUREN 4 WEKEN	Andere keuzes voor Xtreme-stoffen zie kleursten pagina 88
	Zwart C11	Blauw C06	Antraciet C38				
Per 50 stuks van dezelfde kleur				28 €/Stuk			

BESCHIKBARE KLEUREN						MEA 220XR/SKN 38 €	GARANTIE 5 jaar
	Zwart XR 009	Blauw XR 026	Rood XR 079	Antraciet XR 046	Imitatieleer SKN		
Per 50 stuks van dezelfde kleur						36 €/Stuk	

LEVERINGSTERMIJN
KLEUREN 4 WEKEN

Andere keuzes voor Xtreme-stoffen
zie kleursten pagina 88

Vegas Bezoeker



MEA VEGAS VIS

199€

- Bezoekersstoel met zwarte netwaving rugleuning
- Koudgevormde stoffen zitting in schuim met dichtheid 45 kg/m³
- Buisstructuur in geschilderd epoxystaal met doppen in zwart polyurethaan die geen sporen nalaten
- Zwarte armleuningen in polyurethaan
- Stapelbaar per 5 stuks

GARANTIE
5
jaar

BIFMA
ANSI/BIFMA X5.-2002

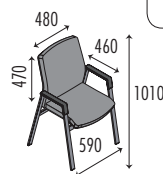

BESCHIKBARE KLEUR

Zwart (NR)

MEA 460

MEA 460

219€

- Grote zitting en ergonomische rugleuning met volledig bekleed profiel
 - Niet-ontvlambare stoffen bekleding M1
 - Sledestructuur in aluminium epoxymetaal



GARANTIE
5
jaar

EN 13761

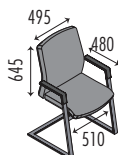

LEVERINGSTERMIJN KLEUREN 4 WEKEN

Andere keuzes voor Xtreme-stoffen zie kleurstalen pagina 88

MEA 920



MEA 920
99€

- Past bij met alle directiestoelen
- Verchroomde structuur
- Armleuningen in imitatieleer
- Niet-ontvlambare afwerking in imitatieleer

GARANTIE
5
jaar

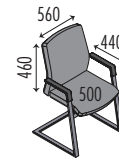

BESCHIKBARE KLEUR	
	Imitatieleer SKN

Padova bezoeker

LEER

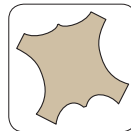

MEA PADOVABDC
339€

- Zwarte leren rugleuning met in de hoogte verstelbare lendensteun
 - Zwarte leren zitting
- Verchroomde metalen sledestructuur

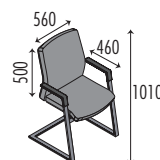

GARANTIE
5
jaar

BESCHIKBARE KLEUR	 Zwart leer (NR)
-------------------	--



MEA 200

MEA 205



MEA 200
54€

- Onderstel met 4 poten in zwarte epoxyverf met korreleffect, grote weerstand tegen strepen, buis van Ø 25 mm
- Antislipdoppen
- Opgevulde zitting en rugleuning
- Niet-ontvlambare stoffen bekleding M1
- Volledige helling van het achterste gedeelte van de zitting en rugleuning



MEA 205
59€

Stapelbaar

Zitting verstevigd met beschermplaat

Gekruiste buisvormige structuur voor een maximale stevigheid



BESCHIKBARE KLEUREN				
	Zwart XR 009	Blauw XR 026	Rood XR 079	Imitatieler SKN

LEVERINGSTERMIJN KLEUREN 4 WEKEN | Andere keuzes voor Xtreme-stoffen zie kleurstalen pagina 88

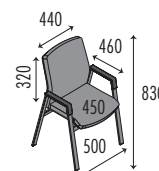

MEA 240

MEA 245



MEA 240
26€

Per 50 stuks van dezelfde kleur **24€/Stuk**

- Afwasbaar, schok- en weerbestendig
- Stapelbaar per 10 stuks
- Antislipdoppen
- Onderstel met 4 verchromde poten, buizen van \varnothing 18 mm
- Op een metalen structuur vastgeschroefde schelp





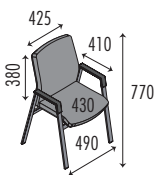



MEA 245
30€

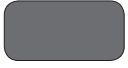

- Stoel met bevestigingssysteem
- Leveringstermijn van 4 weken

GARANTIE
5
jaar

			
BESCHIKBARE KLEUREN	Zwart K02	Antraciet K05	Lichtblauw K09

					
LEVERINGSTERMIJN KLEUREN 4 WEKEN	Rood K30	Donkerblauw K31	Oranje K33	Bruin K51	Groen K59

MEA 280



- Onderstel met 4 verchromde poten met antislipdoppen
- Stapelbaar per 6 stuks

MEA 280
69€

GARANTIE
5
jaar

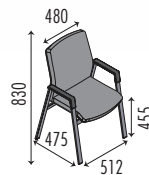

BESCHIKBARE KLEUREN		
	Wit BL	Antraciet GA

MEA 220 PL



- Onderstel met 4 poten uit zwart epoxy metaal met antislipdoppen
- Stapelbaar per 12 stuks

MEA 220 PL
29€

GARANTIE
3
jaar

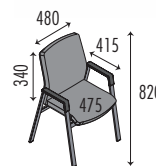

BESCHIKBARE KLEUREN		
	Noir K02	Bleu foncé K31

LEVERINGSTERMIJN KLEUREN 4 WEKEN							
	Antraciet K05	Lichtblauw K09	Rood K30	Donkerblauw K31	Oranje K33	Bruin K51	Groen K59

MEA 260



MEA 260
54€



- Stoel met structuur met 4 buisvormige poten in staal
- Verchromde structuur met antisliddoppen
- Zitting in polypropyleen
- Beschikbaar in 8 kleuren
- Stapelbaar per 6 stuks

GARANTIE
3
jaar

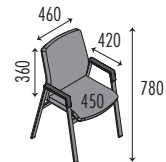

EN 13761



MEAAL260

OPTIE	Verbindingsstuk	18€	MEAAL260
-------	-----------------	------------	----------



LEVERINGSTERMIJN KLEUREN 4 WEKEN								
	Blauw P71	Grijs P72	Oranje P73	Zwart P74	Rood P75	Groen P77	Wit P78	Beige P79

STOELN VOOR ATELIER, LABORATORIUM, TEKENAARS

MEA 30



MEA 30
129€

- Multifunctionele stoel
- Zitting en rugleuning in zwart polyurethaan
- Asynchroon systeem met regeling van de veerkracht en blokkering in meerdere posities
- Onderstel in zwart kunststof kruisvoet
- Optie: voetsteun

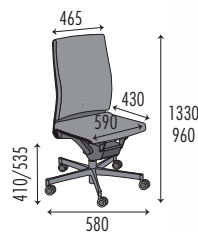
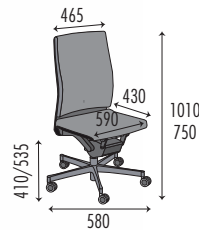

ASynchroon

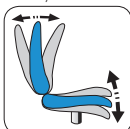

GARANTIE
5
jaar

EN 1335 1-2-3

OPTIES	Verchroomde voetsteun	35€	MEAAP50
	Doppen	10€	MEAPAT

MEA 10



MEA 15

- Krukje met in de hoogte verstelbare zitting in zwart polyurethaan
- Onderstel in zwart gewapend nylon

- Krukje met in de hoogte verstelbare zitting in zwart polyurethaan
- Verchroomde voetsteun
- Hoge steldop
- Onderstel in zwart gewapend nylon

MEA 10
64€

MEA 15
109€

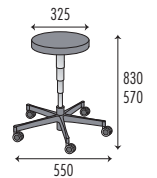
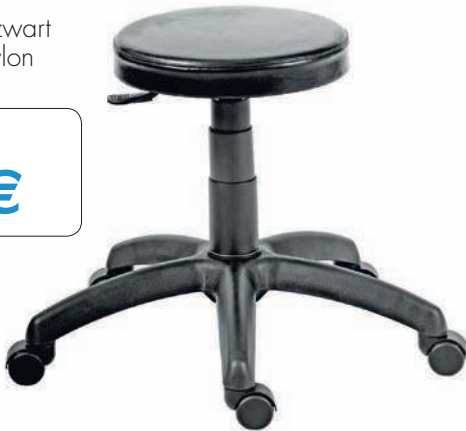
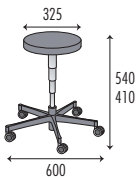

MEA 60

MEA 80

OPTIES	Wieljes voor harde ondergrond	10€	MEARSD3
	Doppen	10€	MEAPAT

MEA 80
139€

MEA 20



MEA 20
99€

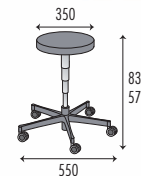

MEA 60
104€

- Stoel met in de hoogte verstelbare houten zitting en rugleuning
- Onderstel in zwart gewapend nylon

- Stoel met in de hoogte verstelbare houten zitting en rugleuning
- Permanent contact
- Hoge steldop
- Onderstel in zwart gewapend nylon

- Krukje met in de hoogte verstelbare houten zitting
- Verchroomde voetsteun
- Hoge steldop
- Onderstel in zwart gewapend nylon

MEA 2300

(Leveringstermijn 4 weken)



MEA 2300
170€

- Eersteklas besprekingsstoel met of zonder arMLEUNINGEN, bestaande uit een schelp van 7 multiplexlagen in beukenhout
- Afwerking zitting en rugleuning met 3 multiplexlagen in beukenhout en een keuze van 12 kleuren, gedeeltelijk bekleed met Xtreme-stof op schuim met een dichtheid van 40 kg/m³
- Afwerking arMLEUNINGEN in gekleurde multiplex in beukenhout
- Onderstel met 4 poten met Ø 22 mm met verstevigingsstang 5x30 mm
- Geluiddempende antislipdoppen
- Beveiliging tegen schokken tijdens het stapelen
- Stapelbaar per 10 stuks
- Leveringstermijn 4 weken

GARANTIE
5
jaar

EN 13761

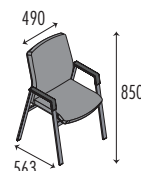

MEAAZURNUM



MEAAZURRCD



OPTIES			
	Transportwagentje	140€	MEAAZURCHA
	Magnetische nummering	4€	MEAAZURNUM
	Verbindingsstuk	30€	MEAAZURRCD
	Besprekingstafel	99€	MEAAZURTBL



MEA 2350
210€

MULTIPLEXKLEUREN								
	Beuk	Els	Sinaasappel	Cognac	Mahonie	Kersenhout	Palissander	Notelaar
	1007	1040	1010	1008	1016	1042	1023	1031

MULTIPLEXKLEUREN				
	Wengé	Zwart	Appelboom	Antraciet
	1033	1043	1025	1.06S

KLEUREN STOFFEN Keuzes voor Xtreme-stoffen zie kleurstalen pagina 88

Denver (Leveringstermijn 4 weken)

- Stoelen in geperforeerd metaal met verchroomde randen
- Bankjes van 2 tot 5 uitgeruste plaatsen aan de uiteinden van de armleuningen
- Hoogte zitting: 400 mm



MEA DENVER03
399 €



MEA DENVER02
329 €



Bankje met 2 plaatsen	1230 x 680 x 800mm	329 €	MEA DENVER02
Bankje met 3 plaatsen	1805 x 680 x 800mm	399 €	MEA DENVER03
Bankje met 4 plaatsen	2380 x 680 x 800mm	529 €	MEA DENVER04
Bankje met 5 plaatsen	2955 x 680 x 800mm	669 €	MEA DENVER05



MEA DENVER05
669 €



MEA DENVER04
529 €

GARANTIE
2
jaar

Lage fauteuils



MEA 2500

Lage eenpersoonsfauteuil

MEA 2500SKN
169€

- Steun voor zitting/rugleuning in multiplex in beukenhout
- Hogedichtheidsschuim bekleed met niet-ontvlambaar zwart imitatieleer
- Uitgerust met verstelbare doppen

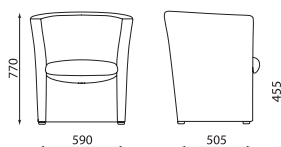

GARANTIE
5
jaar

EN 13761

MEA 2550

Lage tweepersoonsfauteuil

MEA 2550SKN
289€

BESCHIKBARE
KLEUR

Imitatieleer
SKN

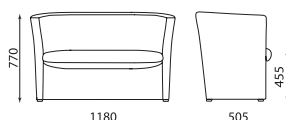

Sofa's



- Een-, twee- of driepersoonssofa's in polyurethaanschuim met houten structuur en verchromde poten
- Bekleding in imitatieleer
- Tafels in rookglas, weerstand 20 kg, houten beklede structuur en verchromde poten



MEA 3550
549€

MEA 3600
299€

Eenpersoonssofa	B930 x D550 x H650 mm	429€	MEA 3500
Tweepersoonssofa	B1450 x D550 x H650 mm	549€	MEA 3550
Driepersoonssofa	B1980 x D550 x H650 mm	699€	MEA 3560
Vierkante tafel	B620 x D620 x H390 mm	299€	MEA 3600
Rechthoekige tafel	B1270 x D620 x H390 mm	449€	MEA 3620
lage eenpersoonsfauteuil	B620 x D620 x H390 mm	229€	MEA 3545
lage tweepersoonsfauteuil	B1270 x D620 x H390 mm	299€	MEA 3555









LEVERINGSTERMIJN KLEUREN 4 WEKEN				
	Grijs SK 01	Wit SK 02	Zwart SK 03	Donkerblauw SK 10

EN 1335 1-2-3

GARANTIE
3
jaar

Kleurstalen van de stoffen voor stoelen

CAGLIARI							 GARANTIE 3 jaar
	Rood C02	Blauw C06	Zwart C11	Bordeaux C29	Groen C34	Antraciet C38	

SAMENSTELLING:

92 % synthetische vezels
8 % andere vezels







GEWICHT: 270 gr/m²



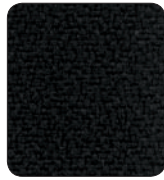

SLIJTWEERSTAND:

25.000 Martindale-cycli

LEER				IMITATIELEER  Blauw SKB	 Zwart SKN	GEWICHT: 400 gr/m ² BRANDWEERSTAND: Sigaret EN 1021-1 Lucifer EN 1021-2
	Zwart NZ					
<p>SAMENSTELLING: 100 % leer</p> <p>SAMENSTELLING: 20 % polyester - 80 % vinyl</p>						

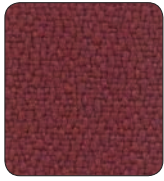
Niet-ontvlambare stoffen

XTREME PLUS							 GARANTIE 10 jaar
	Zwart XR 009	Donkerblauw XR 026	Antraciet XR 046	Lichtblauw XR 073	Rood XR 079	Donkergrijs XR 081	

XTREME PLUS						
	Lichtgrijs XR 094	Bordeaux XR 136	Lichtgroen XR 156	Middelgroen XR 159	Turquoise XR 160	Oranje XR 168

SAMENSTELLING:

100 % FR-polyestervezel

GEWICHT: 310 gr/m²

SLIJTWEERSTAND:

100.000 Martindale-cycli

BRANDWEERSTAND:

Sigaret EN 1021-1 - Lucifer EN 1021-2
Niet-ontvlambaar M1 - BS7176CRIB5

LICHTECHTHEID:

6 (schaal van 1 tot 7)

De opties

MEAST36CR

40€



Onderstel in gepolijst aluminium

MEAST36ALU

40€



Onderstel in gepolijst epoxyaluminium

MEARSD3 (set van 5 wieltjes)

10€

Wieltjes voor harde ondergrond

De stoelen in deze catalogus zijn oorspronkelijk met wieltjes voor tapijt uitgerust. Voor gebruik op een harde ondergrond (parket, tegels, linoleum, ...) zijn er speciale wieltjes met een rubberen wielband nodig.



De mechanismen

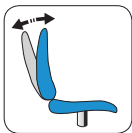

PERMANENT CONTACT

De rugleuning van de stoel blijft permanent in contact met de rug. Ze begeleidt automatisch de beweging van de rug en biedt steun en comfort. De helling van de rugleuning kan ook in een gekozen positie worden geblokkeerd. De hoogte van de zitting is verstelbaar.



SYNCHROON

De rugleuning en zitting bewegen synchroon. De veerkracht van het mechanisme is regelbaar naargelang het gewicht van de gebruiker. De bewegingen van de gebruiker worden zo automatisch gevolgd en vergemakkelijkt. Het is mogelijk om de verkregen posities te blokkeren. De zitting is in de hoogte verstelbaar.

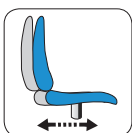

VERSCHUIFBARE ZITTING

De stoel heeft dezelfde kenmerken voor de synchrone mechanismen als voor de synchrone verschuiving; de zitting kan bovendien worden verschoven om te regelen hoe diep ze komt (tot 5 cm).

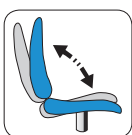

KANTELEN

De stoel kantelt van voor naar achter dankzij een mechanisme in het midden van de zitting. De verkregen positie is bijzonder ontspannend. De zitting is in de hoogte verstelbaar.



KANTELEN EN VERSCHUIVEN

De stoel kantelt van voor naar achter dankzij een mechanisme vooraan de zitting. Daardoor kan de gebruiker de voeten op de grond houden bij het kantelen. Het is mogelijk om de verkregen posities te blokkeren. De zitting is in de hoogte verstelbaar.

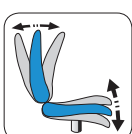

ASYNCHROON

De twee verschillende hendels bieden de mogelijkheid om de helling van de zitting individueel te regelen en op die manier kunt u gemakkelijk een specifieke helling voor de zitting en de rugleuning kiezen.

AZUR-besprekingstafels



- Verchroomd onderstel
- Gemelamineerde plaat met ABS-stootranden
- Stapelbaar tot 5 stuks
- Transportwagentje voor stapelbare tafels
- Leveringstermijn 4 weken



Wit	Zwart	Lichtgrijs	Antraciet	Basalt	Esdoorn	Beuk	Havanna	Calvados
BI	CC	MP	MS	BZ	NE	NB	NT	CV

GEMELAMINEERDE
KLEUREN



Transportwagentje voor AZUR-tafels
82 x 62 x 15 cm

MEA AZUR CHA
140€



			
Donkere notelaar NN	Lichte notelaar NP	Wengé NG	Iep NO

OPTIES	Magnetische nummering	4€	MEAAZURNUM
	Verbindingsstuk	30€	MEAAZURRCD



Laat u verrassen! De AZUR-tafels zullen uw idee van een vergaderzaal grondig overhoopgooien. De AZUR-tafels zijn gemakkelijk op te bergen, te verplaatsen en te combineren. Kortom, geen uitdaging is te groot! De tafels kunnen verticaal worden gestapeld zodat de opslagruimte optimaal wordt gebruikt. Dankzij de mogelijke opstelling in rijen verandert uw zaal in een oogwenk in een vergaderzaal.



AZUR tafels
70 x 50 x 74 cm

MEA AZUR TBL
99€



Stapelbaar per 5

GARANTIE
5
jaar

EN 13761

MEA 2350
210€

Zie pagina 84
Stapelbaar per 10

TBL 6060

- Vierkante metalen tafel in epoxyaluminium, bestaande uit 2 glazen bladen
- Steldoppen in pvc
- Afmetingen: B60 x D60 x H47 cm

TBL 6060
189€



GARANTIE
2
jaar

TBL 9060

- Rechthoekige metalen tafel in epoxyaluminium, bestaande uit 2 glazen bladen
- Steldoppen in pvc
- Afmetingen: B90 x D60 x H47 cm

TBL 9060
219€



TP 160 HA TP 180 HA

TP160HA
129€

TP180HA
139€

- Plooiptafel, stapelbaar per 10 stuks
- Stalen structuur in epoxyaluminium
- Gemelamineerde plaat met natuurlijke afwerking in beukenhout met ABS-stootranden
- Dikte van de plaat 18 mm

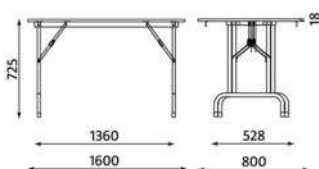
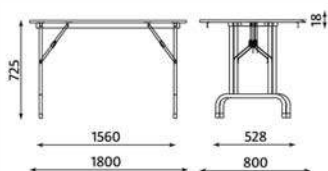

GARANTIE
2
jaar

TP 120 HC

- Plooiptafel, stapelbaar per 10 stuks
- Gemelamineerde plaat met natuurlijke afwerking in beukenhout met ABS-stootranden
- Dikte van de plaat: 25 mm
- Verchromde metalen structuur

TP120HC
169€

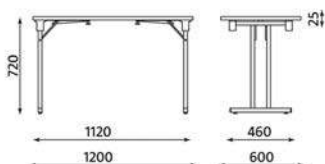



- Maximale indeling in een minimaal volume, gemakkelijk te raadplegen en uit te schuiven
- 3 hoogtes, 100 tot 250 hangmappen op eenzelfde grondoppervlakte
- Laden op telescopische geleiders, schuiven heel gemakkelijk en uiterst stil
- Volledig uitschuifbaar zodat u uw dossier gemakkelijker kunt raadplegen
- Ingebouwd antikantelsysteem, waardoor slechts één lade tegelijk kan worden geopend
- Centrale vergrendeling voor alle laden
- Etikethouder
- Het monoblokontwerp verzekert met zijn inwendige versterkingen een perfecte stabiliteit, een grote weerstand en laat toe de kast zelfs beladen te verplaatsen
- Verzorgde productie in gelakt plaatstaal
- Maximaal ladegewicht: 35 kg.

Afmetingen: B47 x D63 cm, 3 modellen in 3 kleuren

VG4T.GG
329 €



VG3T.GG
299 €

VG2T.GG
249 €

- Centrale sluiting
- Plaats voor hangmappen (A4, folio, groot folio)
- Soepel en stil schuiven van de laden
- Handvat met etikethouder
- Antikantelsysteem
- Volledig uitschuifbaar voor gemakkelijker raadplegen van dossiers

BESCHRIJVING	KLEUR	AFMETINGEN	€	REF
4 laden (capaciteit 200 dossiers)	Grijs	H = 132 cm	329 €	VEG4T.GG
4 laden (capaciteit 200 dossiers)	Antraciet	H = 132 cm	329 €	VEG4T.GA
4 laden (capaciteit 200 dossiers)	Alu	H = 132 cm	344 €	VEG4T.AL
3 laden (capaciteit 150 dossiers)	Grijs	H = 102 cm	299 €	VEG3T.GG
3 laden (capaciteit 150 dossiers)	Antraciet	H = 102 cm	299 €	VEG3T.GA
3 laden (capaciteit 150 dossiers)	Alu	H = 102 cm	309 €	VEG3T.AL
2 laden (capaciteit 100 dossiers)	Grijs	H = 71 cm	249 €	VEG2T.GG
2 laden (capaciteit 100 dossiers)	Antraciet	H = 71 cm	249 €	VEG2T.GA
2 laden (capaciteit 100 dossiers)	Alu	H = 71 cm	259 €	VEG2T.AL
blokkeerstukken in epoxy metaal	Zwart	per 5 stuks	49 €	VEG24.IT



BISLEY

Metalen klapdeurkasten

Monoblokconstructie

- Centrale vergrendeling met 3-puntssluiting
- Volledig geïntegreerde handgreep
- Voorzien van 1 of 4 zwarte legplanken, geschikt voor hangmappen

VEG001.GG

219€



VEG002.GG

289€

GARANTIE

5
jaar



BESCHIKBARE KLEUR

Gris (GG)



AFMETINGEN	KLEUR	LEGPLANKEN	€	REF
B92 x D40 x H100 cm	Grijs	1	219€	VEG001.GG
B92 x D40 x H195 cm	Grijs	4	289€	VEG002.GG
extra legplank			20€	VEG002/100

VEG15T.GG

259€



VEG10T.GG

179€



Multifunctionele ladekasten

(Leveringstermijn 4 weken)

- Metalen ladekasten met 10 of 15 laden
- Hoogte lade = 51 mm



BESCHIKBARE KLEUR

Gris (GG)

AFMETINGEN	KLEUR	LADEN	€	REF
B28 x D38 x H67 cm	Grijs	10	179€	VEG10T.GG
B28 x D38 x H94 cm	Grijs	15	259€	VEG15T.GG

BISLEY

Multifunctionele kasten (Leveringstermijn 4 weken)

Onmisbaar voor het klasseren van een groot volume fiches, cd's, video's

- Volledig uitschuifbaar
- Antikantelsysteem
- Centraal slot
- Met handvat en etikethouder
- Kleur: grijs



BESCHRIJVING	AFMETINGEN KASTEN	MAX. AFMETINGEN FICHES	CAP. FICHES	CAP. CD'S	CAP. VIDEO'S	€	REF
9 laden	B622 x D413 x H1321 mm	152 x 102 mm	41.400	-	-	1429€	VEGB64.GG
7 laden	B622 x D518 x H1321 mm	203 x 127 mm	32.200	1.120	294	1259€	VEGB85.GG
6 laden	B622 x D568 x H1321 mm	228 x 152 mm	27.600	960	252	1099€	VEGB96.GG



Scheidingen voor de kasten (Leveringstermijn 4 weken)

Handig bij het opbergen van uw fiches, cd's of video's

- 2 rijen kaarten per lade
- 2 metalen hulpstukken om de kaarten op hun plaats te houden
- Bij B85 en B96 zijn laden voorzien van een blokkeersysteem



BESCHRIJVING	HOEEVEELHEID	€	REF
Voor kast met 9 laden	10 stuks	44€	VEGB64.SEP
Voor kast met 7 laden	10 stuks	44€	VEGB85.SEP
Voor kast met 6 laden	10 stuks	44€	VEGB96.SEP



Garderobes (Leveringstermijn 4 weken) Stijl en flexibiliteit

- Garderobes met 1, 2, 4 of 6 compartimenten
- De modellen met 1 en 2 deuren zijn voorzien van een staaf en klerhangers
- Een slot en etikethouder per compartiment
- Met handvat en etikethouder
- Kleur: grijs (andere kleuren beschikbaar op bestelling)

Deze garderobes passen in elke omgeving: sportzaal, ziekenhuis, school, industrieel of commercieel complex

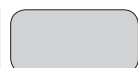

BESCHIKBARE KLEUR

Grijs (GG)

BESCHRIJVING	AFMETINGEN KASTEN	BINNENHOOGTE	€	REF
1 compartiment	B305 x D457 x H1802 mm	1475 mm tot legplank	174€	VEGCLK181.GG
2 compartimenten	B305 x D457 x H1802 mm	847 mm tot legplank	179€	VEGCLK182.GG
4 compartimenten	B305 x D457 x H1802 mm	404 mm tot legplank	199€	VEGCLK184.GG
6 compartimenten	B305 x D457 x H1802 mm	263 mm tot legplank	249€	VEGCLK186.GG



BISLEY

Archiefkasten (Leveringstermijn 4 weken)

Ideaal voor het klasseren van uw dossiers die frequent worden geraadpleegd en dit zowel voor individueel als voor collectief gebruik.

De archiefkast biedt tot 30 % meer capaciteit dan een ladekast.

Doordat de bakken 440 mm kunnen worden uitgeschoven, zijn deze kasten ook zeer geschikt voor krappe ruimtes.

- Antikantelsysteem
- Moedersleutel verkrijgbaar op aanvraag
- Centrale vergrendeling voor alle laden
- Flush front
- Opberg ruimte: 2 rijen A4 "Front to Back" of 1 rij folio "Side to Side"
- Kleur: grijs

VEG08SF2.GG

699€



BESCHRIJVING	AFMETINGEN	€	REF
3 laden	B800 x D470 x H1021 mm	899€	VEG08SF3.GG
4 laden	B800 x D470 x H1301 mm	1099€	VEG08SF4.GG

GARANTIE

5
jaar



VEGFCB40.GG
VEGFCB41.GG

2553€

Plannenkasten van A0- en A1-formaat (Leveringstermijn 4 weken)

Plannenkasten beschikbaar in A0- en A1-formaat, met modules van 5 laden voorzien van een centraal slot. De laden zijn voorzien van telescopische kogellagers voor een zachte en geluidloze werking.



- Elke lade kan een gewicht tot 50 kg dragen
- Twee etikethouders per lade
- Een achterwand vermijdt dat de documenten achter de ladebakken vallen

BESCHRIJVING	AFMETINGEN	€	REF
A0-module met 5 laden (met sokkel en bovenblad)	B1359 x D927 x H508 mm	1399€	VEGFCB40.GG
A0-tussenmodule met 5 laden (zonder sokkel, zonder bovenblad)	B1359 x D927 x H406 mm	1154€	VEGFCB41.GG
A1-module met 5 laden (met sokkel en bovenblad)	B1010 x D691 x H508 mm	1134€	VEGFCB30.GG
A1-tussenmodule met 5 laden (zonder sokkel, zonder bovenblad)	B1010 x D691 x H406 mm	934€	VEGFCB31.GG
Scheiding voor lade (per 2)		5€	VEGPDF

BISLEY

Enkele en dubbele ladekasten "light"

De enkele of dubbele ladekasten "light" bieden grotendeels dezelfde voordelen als het hoogwaardige BS-model, en vormen tegelijkertijd een vereenvoudigd technisch aanbod tegen een zeer scherpe prijs.

- Doorlopende handgrepen met etikethouders vooraan
- Monoblokconstructie
- Volledig uitschuifbare kogellagers
- Antikantelsysteem en centrale sluiting
- Volle wanden om elk soort document te klasseren
- Algemeen slot voor gebruik van een looper, met twee genummerde sleutels

GARANTIE
5
jaar

BESCHIKBARE KLEUREN



Grijs (GG)



Antraciet (GA)



VEGECO4T.GG

249 €

VEGECO3T.GG

229 €

VEGECO2T.GG

199 €





VEGECO4TD.GG
539€



VEGECO4TD.GA
539€

Enkele ladekasten "light"

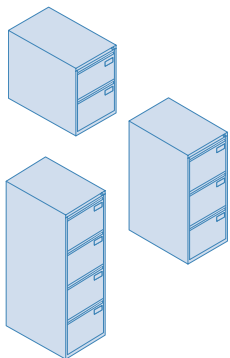

BESCHRIJVING	AFMETINGEN	LADEN	€	REF
Enkele ladekasten "light"	B470 x D622 x H711 mm	2	199€	VEGECO2T
Enkele ladekasten "light"	B470 x D622 x H1016 mm	3	229€	VEGECO3T
Enkele ladekasten "light"	B470 x D622 x H1321 mm	4	249€	VEGECO4T

In de enkele ladekast voor Foolscap-formaat kunnen hangmappen met tussenafstand van 330 mm, 365 mm en 390 mm worden geklasseerd.

Dubbele ladekasten "light" (Leveringstermijn 4 weken)

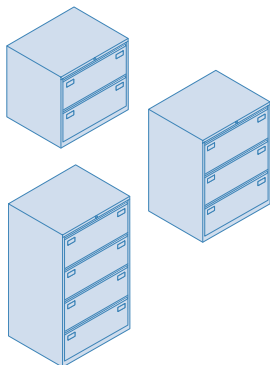

BESCHRIJVING	AFMETINGEN	LADEN	€	REF
Dubbele ladekasten "light"	B800 x D622 x H711 mm	2	469€	VEGECO2TD
Dubbele ladekasten "light"	B800 x D622 x H1016 mm	3	529€	VEGECO3TD
Dubbele ladekasten "light"	B800 x D622 x H1321 mm	4	539€	VEGECO4TD

Uitrusting voor enkele ladekasten "light"



BESCHRIJVING	HOEEVEELHEID	€	REF
Zwartmetalen blokkeerstukken, Foolscap-formaat	per 5 stuks	32€	VEGECO24IT











Verticale roldeurkasten "Euro" (Leveringstermijn 4 weken behalve * uit voorraad)

De praktische en concurrentiële roldeurkast "Euro" biedt een eersteklas, sobere en elegante lijn. Bij dit voordelige gamma is moderniteit op de budgettaire beperkingen afgestemd.

- Monoblok in gelast staal van uitstekende kwaliteit 9/10e met versterkte sokkel
- Slot met veiligheidssysteem dat forceren onmogelijk maakt
- Slot met set van 2 genummerde en buigzame sleutels en onderling verwisselbare cilinder
- 4 steldoppen onderaan (doorsnede 2 cm) toegankelijk vanaf de binnenkant om de belasting te regelen
- Bimetalen rolluiken in pvc, gecertificeerd volgens brandklasse M1 (REHAU)
- Geschikt voor 6 rijen hangmappen op een hoogte van 1980 mm
- Telescopisch kader voor 3 rijen hangmappen (breedte 120 mm)
- Merktekens voor de plaatsing van planken voor het gebruik van hangmappen of klasseerrekken (om de 19 mm)
- Comfortabele handgreep op elke gewenste hoogte
- Verhoogde rangschikkingscapaciteit met een nuttige breedte van 107 cm op een lengte van 120 cm
- Verstelbare legplank ter bescherming van de onderste rail en toegang tot de bekabeling
- Platte bodem

GARANTIE
5
jaar



KLEUREN ROLLUIKEN	 Wit (BL)	 Donkergrijs (GA)	 Lichtgrijs (GG)	 Zilver (AL)	 Zwart (NZ)	 Beige (BE)	 Beukenhout (HE)	 Kersenhout (ME)
KLEUREN BEHUIZING	 Wit (BWW)	 Grijs (GG)	 Antraciet (GA)	 Aluminium (AL)	 Zwart (NZ)	 Beige (BE)		

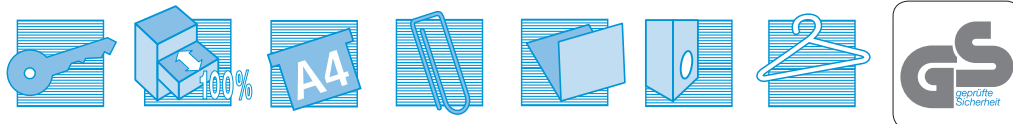





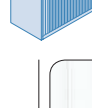
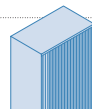
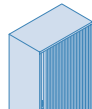
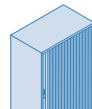
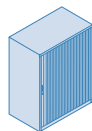
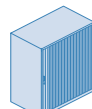
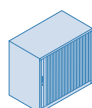
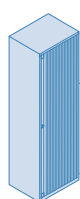



**BREEDTE
600 & 800 mm**

(Leveringstermijn 4 weken)



BESCHRIJVING	AFMETINGEN	KLEUREN BEHUIZING	€	REF
4 leglanken voor hangmappen + 1 rail voor hangmappen onder het bovenblad	B600 x D430 x H1980 mm	BW-GG-GA-NZ-BE	340	ET406/19/4S
		Aluminium	358	
1 legplank met kleeerhangers	B600 x D430 x H1980 mm	BW-GG-GA-NZ-BE	372	ET406/19/WS
		Aluminium	390	
Verhoog	B800 x D430 x H490 mm	BW-GG-GA-NZ-BE	219	ET408/TB
		Aluminium	230	
1 legplank voor hangmappen + 1 rail voor hangmappen onder het bovenblad	B800 x D430 x H695 mm	BW-GG-GA-NZ-BE	253	ET408/06/1S
		Aluminium	265	
2 leglanken voor hangmappen + 1 rail voor hangmappen onder het bovenblad	B800 x D430 x H1030 mm	BW-GG-GA-NZ-BE	281	ET408/10/2S
		Aluminium	296	
2 leglanken voor hangmappen + 1 rail voor hangmappen onder het bovenblad	B800 x D430 x H1180 mm	BW-GG-GA-NZ-BE	306	ET408/11/2S
		Aluminium	321	
3 leglanken voor hangmappen + 1 rail voor hangmappen onder het bovenblad	B800 x D430 x H1330 mm	BW-GG-GA-NZ-BE	311	ET408/13/3S
		Aluminium	326	
3 leglanken voor hangmappen + 1 rail voor hangmappen onder het bovenblad	B800 x D430 x H1637 mm	BW-GG-GA-NZ-BE	363	ET408/17/3S
		Aluminium	381	
4 leglanken voor hangmappen + 1 rail voor hangmappen onder het bovenblad	B800 x D430 x H1980 mm	BW-GG-GA-NZ-BE	402	ET408/19/WP
		Aluminium	422	

KLEUREN ROLLIJKEN	 Wit (BL)	 Donkergrijs (GA)	 Lichtgrijs (GG)	 Zilver (AL)	 Zwart (NZ)	 Beige (BE)	 Beukenhout (HE)	 Kersenhout (ME)
-------------------	--	--	---	---	---	--	---	---

KLEUREN BEHUIZING	 Wit (BW)	 Grijs (GG)	 Antraciet (GA)	 Aluminium (AL)	 Zwart (NZ)	 Beige (BE)
-------------------	--	--	--	--	---	--

Verticale roldeurkasten "Euro" (Leveringstermijn 4 weken behalve * uit voorraad)



BESCHRIJVING	AFMETINGEN	KLEUREN BEHUIZING	€	REF
Verhoog	B1000 x D430 x H490 mm	BW-GG-GA-NZ-BE	258	ET410/TB
		Aluminium	270	
1 legplank voor hangmappen + 1 rail voor hangmappen onder het bovenblad	B1000 x D430 x H695 mm	BW-GG-GA-NZ-BE	283	ET410/06/1S
		Aluminium	298	
2 legplanken voor hangmappen + 1 rail voor hangmappen onder het bovenblad	B1000 x D430 x H1030 mm	BW-GG-GA-NZ-BE	309	ET410/10/2S*
		Aluminium	327	
2 legplanken voor hangmappen + 1 rail voor hangmappen onder het bovenblad	B1000 x D430 x H1180 mm	BW-GG-GA-NZ-BE	355	ET410/11/2S
		Aluminium	374	
3 legplanken voor hangmappen + 1 rail voor hangmappen onder het bovenblad	B1000 x D430 x H1330 mm	BW-GG-GA-NZ-BE	366	ET410/13/3S
		Aluminium	384	
3 legplanken voor hangmappen + 1 rail voor hangmappen onder het bovenblad	B1000 x D430 x H1637 mm	BW-GG-GA-NZ-BE	424	ET410/17/3S
		Aluminium	447	
4 legplanken voor hangmappen + 1 rail voor hangmappen onder het bovenblad	B1000 x D430 x H1980 mm	BW-GG-GA-NZ-BE	436	ET410/19/4S*
		Aluminium	459	

*BESCHIKBARE KLEUREN : BW/BL - GG/GG - GA/GA - AL/AL

KLEUREN ROLLIJKEN	Wit (BL)	Donkergrijs (GA)	Lichtgrijs (GG)	Zilver (AL)	Zwart (NZ)	Beige (BE)	Beukenhout (HE)	Kersenhout (ME)

KLEUREN BEHUIZING	Wit (BW)	Grijs (GG)	Antraciet (GA)	Aluminium (AL)	Zwart (NZ)	Beige (BE)

BREEDTE 1200 mm

(Leveringstermijn 4 weken behalve * uit voorraad)

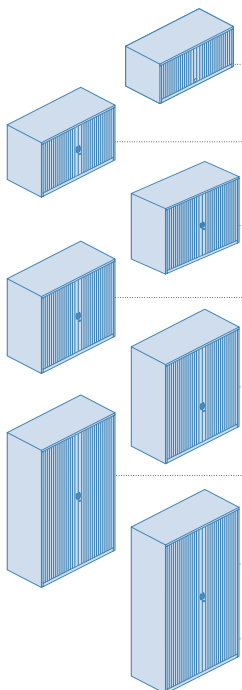

BESCHRIJVING	AFMETINGEN	KLEUREN BEHUIZING	€	REF
Verhoog	B1200 x D430 x H490 mm	BW-GG-GA-NZ-BE	296	ET412/TB
		Aluminium	310	
1 legplank voor hangmappen + 1 rail voor hangmappen onder het bovenblad	B1200 x D430 x H695 mm	BW-GG-GA-NZ-BE	326	ET412/06/1S
		Aluminium	342	
2 legplanken voor hangmappen + 1 rail voor hangmappen onder het bovenblad	B1200 x D430 x H1030 mm	BW-GG-GA-NZ-BE	335	ET412/10/2S*
		Aluminium	353	
2 legplanken voor hangmappen + 1 rail voor hangmappen onder het bovenblad	B1200 x D430 x H1180 mm	BW-GG-GA-NZ-BE	405	ET412/11/2S
		Aluminium	424	
3 legplanken voor hangmappen + 1 rail voor hangmappen onder het bovenblad	B1200 x D430 x H1330 mm	BW-GG-GA-NZ-BE	422	ET412/13/3S
		Aluminium	443	
3 legplanken voor hangmappen + 1 rail voor hangmappen onder het bovenblad	B1200 x D430 x H1637 mm	BW-GG-GA-NZ-BE	451	ET412/17/3S
		Aluminium	474	
4 legplanken voor hangmappen + 1 rail voor hangmappen onder het bovenblad	B1200 x D430 x H1980 mm	BW-GG-GA-NZ-BE	459	ET412/19/4S*
		Aluminium	482	
Scheiding 1/2 hangkast, 1/2 enkele legplanken	B1200 x D430 x H1980 mm	BW-GG-GA-NZ-BE	604	ET412/19/WP
		Aluminium	634	

*BESCHIKBARE KLEUREN : BW/BL - GG/GG - GA/GA - AL/AL

KLEUREN ROLLIJKEN	Wit (BL)	Donkergrijs (GA)	Lichtgrijs (GG)	Zilver (AL)	Zwart (NZ)	Beige (BE)	Beukenhout (HE)	Kersenhout (ME)

KLEUREN BEHUIZING	Wit (BW)	Grijs (GG)	Antraciet (GA)	Aluminium (AL)	Zwart (NZ)	Beige (BE)

Binnenuitrusting voor kasten "Euro" (Leveringstermijn 4 weken)

Door de veelzijdigheid van de binnenuitrusting kan de opbergruimte aan de persoonlijke behoeften worden aangepast en optimaal worden gebruikt.



BESCHRIJVING	BREEDTE	€	REF
Gemengde legplank voor hangmappen	600 mm	15€	ET406SHPS
Gemengde legplank voor hangmappen	800 mm	16€	ET408SHPS
Telescopische lade met antikantelsysteem	800 mm	81€	ET408RD4PS
Telescopisch kader met antikantelsysteem	800 mm	61€	ET408RFPS
Telescopische raadpleeglegplank	800 mm	55€	ET408RSPS
Gemengde legplank voor hangmappen	1000 mm	17€	ET410SHPS*
Telescopische lade met antikantelsysteem	1000 mm	86€	ET410RD4PS
Telescopisch kader met antikantelsysteem	1000 mm	66€	ET410RFPS*
Telescopische raadpleeglegplank	1000 mm	58€	ET410RSPS
Gemengde legplank voor hangmappen	1200 mm	19€	ET412SHPS*
Telescopische lade met antikantelsysteem	1200 mm	90€	ET412RD4PS
Telescopisch kader met antikantelsysteem	1200 mm	76€	ET412RFPS*
Telescopische raadpleeglegplank	1200 mm	67€	ET412RSPS
Kit ½ hangkast + ½ enkele legplanken	1200 mm	32€	ET41219VWSPS



BISLEY

Ladeblokken "Note" met handgrepen aan de zijkant

De ladeblokken van het gamma "Note" komen tegemoet aan budgettaire beperkingen, zonder daarbij de voorliefde voor zuivere lijnen van gewaarborgde kwaliteit uit het oog te verliezen.

- Monoblok uit één stuk gebogen staalplaat
- Zonder lasnaden
- Bovenblad van 6 mm op alle ladeblokken op wieltjes
- Maar één lade tegelijk open
- Uitschuifbare laden: persoonlijke items/papierwaren: 80 % - Hangmappen: 100 %
- Centrale vergrendeling
- Algemeen slot voor gebruik van een looper, met twee genummerde en buigzame sleutels
- Afneembare cilinder



OPTIE	Pennenlade	8€	EN.TP
-------	------------	----	-------

BESCHIKBARE KLEUREN	 Wit (BW)	 Grijs (GG)	 Antraciet (GA)	 Aluminium (AL)
---------------------	---	---	---	---



BESCHRIJVING	AFMETINGEN	LADEN	€	REF
ladeblokken op wieltjes	B420 x D565 x H500 mm	1x papierwaren (H150 mm) 1x hangmappen (H300 mm)	169€	NWA59M1SFT
ladeblokken op wieltjes	B420 x D565 x H500 mm	3x papierwaren (H150 mm)	169€	NWA59M1SSS



BESCHRIJVING	AFMETINGEN	LADEN	€	REF
ladeblokken op steldoppen	B420 x D565 x H695-745 mm	2x papierwaren (H150 mm) 1x hangmappen (H300 mm)	199€	NWA53G7SSF
ladeblokken op steldoppen	B420 x D775 x H695-745 mm	2x papierwaren (H150 mm) 1x hangmappen (H300 mm)	219€	NWA73G7SSF
ladeblokken op steldoppen	B420 x D565 x H695-745 mm	4x papierwaren (H150 mm)	259€	NWA53G7SSSS



Kapstokken

GARANTIE
2
jaar

PTMECO

Kapstokken "Eco"

- Hoogte: 175 cm
- Draaiende kop met 8 doppen in zwart ABS
- Haken voor tassen, sleutels, sjaals
- Paraplubak met druijbak in ABS
- Lichaam in metalen chroombuis van Ø 50 mm
- Onderstel van 57 cm breed
- Perfect stabiel

PTMECO
54€

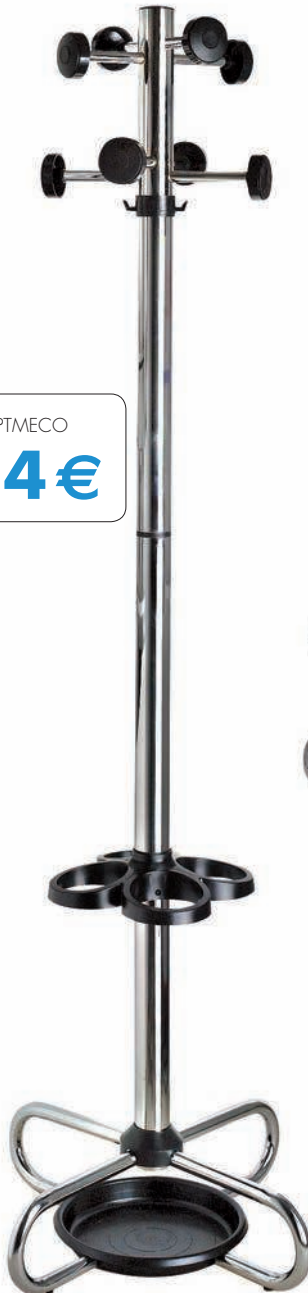

PTMAC

Kapstok "Ontvangst"

- Hoogte: 180 cm breed
- Draaiende kop met 8 doppen in zwart ABS over 2 niveaus
- Haken voor tassen, sleutels, sjaals
- Paraplubak met druijbak in ABS
- Lichaam in zwartgelakte metalen buis met Ø 50 mm
- Sokkel in verzwwaard ABS Ø 43 cm
- Perfect stabiel
- Zwart (11)

PTMAC11
59€

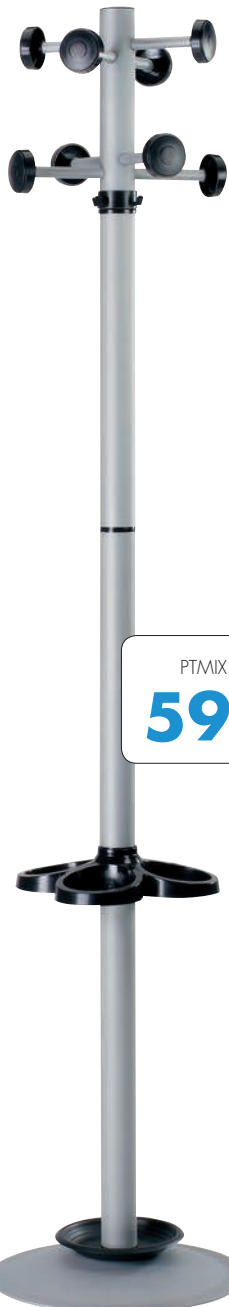

PTMIX11
59€

PTMMIX

Kapstok "Mix"

- Hoogte: 180 cm breed
- Draaiende kop met 8 doppen in zwart ABS
- Haken voor tassen, sleutels, sjaals
- Paraplubak met druijbak in ABS
- Lichaam in gelakte metalen buis in aluminiumkleur met Ø 50 mm
- Sokkel in metaal
- Perfect stabiel
- Zwart (11)

PTMBUD11
49€



PTMBUD

Kapstok "Budget"

- Hoogte: 175 cm breed
- Draaiende kop met 8 doppen in zwart ABS
- Haken voor tassen, sleutels, sjaals
- Paraplubak met druijbak in ABS
- Lichaam in zwartgelakte metalen buis met Ø 50 mm
- Onderstel van 57 cm breed
- Perfect stabiel
- Zwart (11)

Vloerbescherming

Alle producten zijn in duurzaam vinyl vervaardigd.

Door hun gladde oppervlak beschermen ze uw vloer of tapijt, terwijl de schoonheid ervan toch zichtbaar blijft



VLOERBESCHERMING VOOR TAPIJT

De vloerbescherming voor tapijt laat toe om de schoonheid van uw tapijt in de verf te zetten en tegelijkertijd uw tapijt te beschermen tegen een zeer frequent gebruik. Dankzij de "GRIPPER BACK" hecht de vloerbescherming zich zeer goed aan uw tapijt. Door het gladde oppervlak kan u er vlot met uw stoel over rijden.



A. Rechthoekig

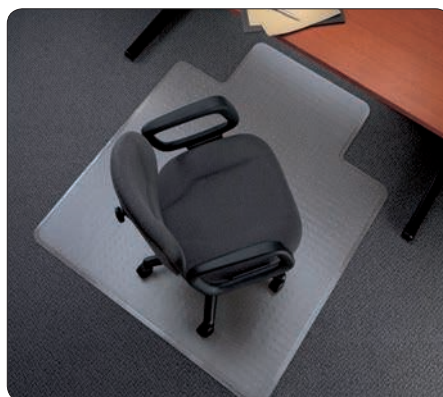

B. Met uitsnijding



MODEL	BESCHRIJVING	AFMETINGEN	€	REF
A	Transparante pvc	B90 x D120 cm	49€	TNX11341
A	Transparante pvc	B120 x D150 cm	87€	TNX11375
B	Transparante pvc	B115 x D134 cm	65€	TNX11373

VLOERBESCHERMING VOOR HARDE ONDERGROND

Deze vloerbescherming is geschikt voor elk type van harde ondergrond, inclusief linoleum, tegels, parket en beton.



A. Rechthoekig

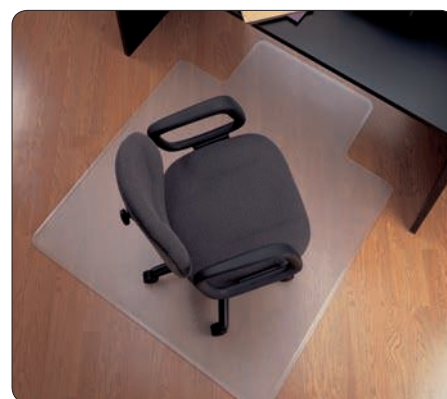

B. Met uitsnijding

MODEL	BESCHRIJVING	AFMETINGEN	€	REF
A	Transparante pvc	B90 x D120 cm	49€	TNX13241
A	Transparante pvc	B120 x D200 cm	92€	TNX13245
A	Transparante pvc	B120 x D150 cm	87€	TNX13275
B	Transparante pvc	B115 x D134 cm	65€	TNX13273

Budgetproducten



Klapdeurkasten

Metalen kast, monoblok voorzien van 4 legplanken geschikt voor hangmappen.

- Deuren kunnen tot 180° worden geopend
- 3-puntssluiting



AFMETINGEN	KLEUR	€	REF
B92 x D42 x H195 cm	Grijs	230€	VEGECO1.GG
B92 x D42 x H195 cm	Antraciet	230€	VEGECO1.GA
B80 x D38 x H178 cm	Grijs	200€	VEGECO4.GG
B80 x D38 x H178 cm	Antraciet	200€	VEGECO4.GA
B120 x D42 x H195 cm	Grijs	310€	VEGECO12.GG
B90 x D60 x H198 cm	Grijs	334€	VEGECO19.GG

COMBINATIE VEGECO1 + VEGECO4:
VEGECO14: 350 € = BESPARING VAN 80 €



BESCHIKBARE KLEUREN

Grijs (GG)

Antraciet (GA)

Gemengde kast garderobe-klassering

Monoblokkast bestaande uit één grote en 3 kleine legplanken, evenals een verticale scheiding voor de garderobe

AFMETINGEN	KLEUR	€	REF
B92 x D42 x H195 cm	Grijs	284€	VEGECO3.GG

BESCHIKBARE KLEUR

Grijs (GG)

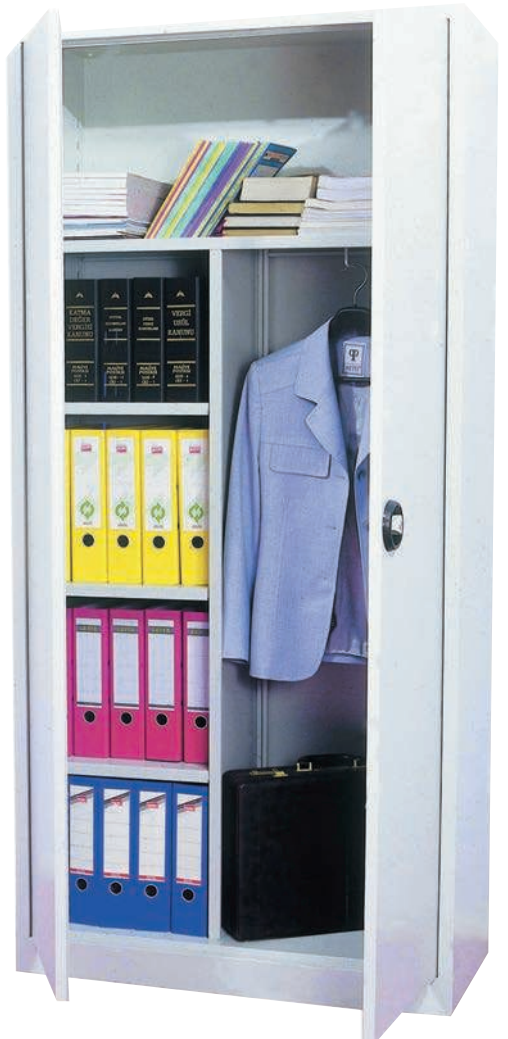



Presentatiekast

Presentatiekast in monoblok, met 5 horizontale legplanken en 5 schuine legplanken om uw documenten te presenteren

AFMETINGEN	KLEUR	€	REF
B92 x D42 x H195 cm	Grijs	299€	VEGECO2.GG

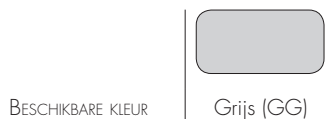

Archiefkast

Kast zonder deuren in monoblok uitgerust met 4 horizontale legplanken voor de archivering van ringmappen

AFMETINGEN	KLEUR	€	REF
B95 x D30 x H198 cm	Grijs	209€	VEGECO60.GG

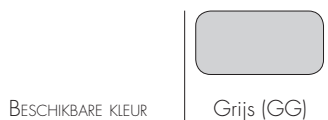

Modulaire rekken

Modulaire rekken om zelf ineen te zetten

- Zeer stevige metalen constructie
- Voorzien van 4 verstelbare legplanken om de 2,5 cm waaraan hangmappen kunnen worden bevestigd

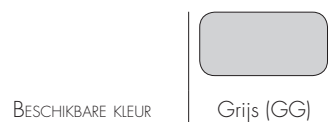

AFMETINGEN	KLEUR	€	REF
Startelement			
B100 x D35 x H198 cm	Grijs	169€	VEGECO71.GG
Aanbouwelement			
B97 x D35 x H198 cm	Grijs	129€	VEGECO72.GG

Budgetproducten

Garderobekasten

Monoblokconstructie met 1 tot 3 deuren, met of zonder tussenwand, voor scheiding van propere en vuile kledij..



VEGECO2CPS
176€



VEGECO3CPS
258€



VEGECO1CPS
114€



VEGECO.BNC90C
78€



BESCHIKBARE KLEUR



Grijs (GG)

OPTIE | Poten | **20€** | VEGECO.CPP

BESCHRIJVING PRODUCT	AFMETINGEN	€	REF
Garderobekast met 1 deur / zonder tussenwand, op sokkel	B30 x D50 x H180 cm	114	VEGECO1CPS
Garderobekast met 2 deuren / zonder tussenwand, op sokkel	B60 x D50 x H180 cm	176	VEGECO2CPS
Garderobekast met 3 deuren / zonder tussenwand, op sokkel	B90 x D50 x H180 cm	258	VEGECO3CPS
Bank voor garderobe	B60 x D80 x H35 cm	54	VEGECO.BNC60C
Bank voor garderobe	B80 x D80 x H35 cm	72	VEGECO.BNC80C
Bank voor garderobe	B90 x D80 x H35 cm	78	VEGECO.BNC90C
Bank voor garderobe	B120 x D80 x H35 cm	104	VEGECO.BNC120C

Hangslot

Slot



VEGECOSPC



OPTIE	Hangslot per eenheid	6€	VEGECOSPC
-------	----------------------	-----------	-----------

VEGECO2CSS
236€

VEGECO1CSS
149€



VEGECO3CSS
356€

Schuin opzetstuk



OPTIE	Poten	20€	VEGECO CPP
-------	-------	------------	------------

BESCHRIJVING PRODUCT	AFMETINGEN	€	REF
Garderobekast met 1 deur / met tussenwand, op sokkel	B40 x D50 x H180 cm	149	VEGECO1CSS
Garderobekast met 2 deuren / met tussenwand, op sokkel	B80 x D50 x H180 cm	236	VEGECO2CSS
Garderobekast met 3 deuren / met tussenwand, op sokkel	B120 x D50 x H180 cm	356	VEGECO3CSS
Schuin dak voor garderobe	B60 x D50 x H20 cm	43	VEGECOTI60C
Schuin dak voor garderobe	B80 x D50 x H20 cm	54	VEGECOTI80C
Schuin dak voor garderobe	B90 x D50 x H20 cm	59	VEGECOTI90C
Schuin dak voor garderobe	B120 x D50 x H20 cm	79	VEGECOTI120C

- Aan elke deur:
- Een bovenste legplank
 - Etikethouder
 - 30 ventilatiesleuven
 - Slot (hangslot optioneel)
 - Haken, staafhanger

Budgetproducten

Kast ½ hangkast

Uitgerust met ventilatiesleuven, een slot of een hangslot, staafhanger, haken

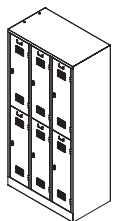

BESCHRIJVING PRODUCT	AFMETINGEN	€	REF
Garderobekast met 4 deuren / schone industrie op sokkel	B60 x D50 x H180 cm	219	VEGECO24CPS
Garderobekast met 6 deuren / schone industrie op sokkel	B90 x D50 x H180 cm	340	VEGECO26CPS
OPTIE	Poten	20€	VEGECOCP



OPTIE	Hangslot per eenheid	6€	VEGECOSPC
-------	----------------------	-----------	-----------



Opbergkolom

5-10-15 deuren op sokkel

Meerdere opbergruimtes, uitgerust met sloten en sleutels

BESCHRIJVING PRODUCT	AFMETINGEN	€	REF
Kolom met 5 deuren op sokkel	B40 x D44 x H195 cm	209€	VEGECO5CSS
Kolom met 10 deuren op sokkel	B78 x D44 x H195 cm	362€	VEGECO10CSS
Kolom met 15 deuren op sokkel	B116 x D44 x H195 cm	514€	VEGECO15CSS

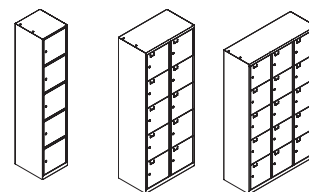

BESCHIKBARE KLEUR

Grijs (GG)

Tafels "Eco"

- Gemelamineerde bladen die voldoende tegengewicht vormen, dikte 25 mm met pvc-stootranden van 3 mm dik
- Metalen kaderstructuur in het grijs of antraciet
- Onderstel met regelbare steldoppen
- De combinatie grijs (G) blad / antraciet (A) structuur is niet beschikbaar

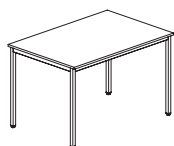
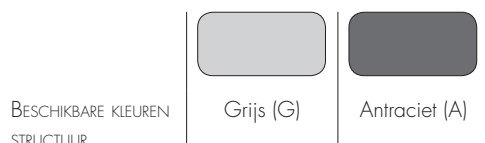

BESCHRIJVING PRODUCT	AFMETINGEN	€	REF
Rechthoekige tafel	B80 x D80 x H75 cm	72€	VEGECO.MTB.R88
Rechthoekige tafel	B120 x D60 x H75 cm	77€	VEGECO.MTB.R126
Rechthoekige tafel	B120 x D80 x H75 cm	82€	VEGECO.MTB.R128
Rechthoekige tafel	B140 x D70 x H75 cm	92€	VEGECO.MTB.R147
Rechthoekige tafel	B160 x D80 x H75 cm	106€	VEGECO.MTB.R168
Rechthoekige tafel	B180 x D80 x H75 cm	114€	VEGECO.MTB.R188
Rechthoekige tafel	B200 x D100 x H75 cm	134€	VEGECO.MTB.R210



Ministerbureaus

- Metaalgrijze structuur met 4 poten, bestaande uit 1 of 2 blokken van 2 of 3 telescopische opbergladen
- Gemelamineerd blad dat voldoende tegengewicht vormt, dikte 25 mm met pvc-stootranden van 3 mm dik
- Ladeblok met centrale sluiting
- Verstelbare steldoppen

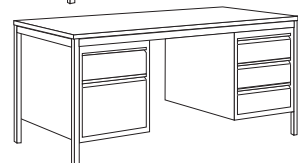
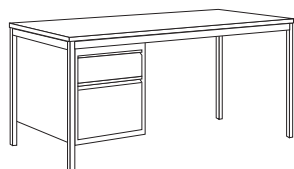

BESCHRIJVING PRODUCT	AFMETINGEN	€	REF
Bureau met 2 of 3 laden	B120 x D80 x H75 cm	239€	VEGECO.ODK128SC
Bureau met 2 of 3 laden	B140 x D80 x H75 cm	249€	VEGECO.ODK148SC
Bureau met 2+3 of 3+3 laden	B160 x D80 x H75 cm	419€	VEGECO.ODK168DC

Budgetproducten

Roldeurkasten in monoblok

- Verticale plaatjes in pvc
- Voorzien van 2 tot 4 legplanken, geschikt voor hangmappen
- Magnetisch profiel over de volledige hoogte voor een perfecte sluiting
- Platte bodem om mappen gemakkelijk uit te trekken
- Verstelbare steldoppen
- 2 genummerde sleutels bijgeleverd



VEGECO33.GG

355 €

		
Grijs (GG)	Antraciet (GA)	Aluminium (AL)

BESCHIKBARE KLEUREN

VEGECO32.GG

289€



AFMETINGEN	KLEUR	€	REF
B120 x D46 x H105 cm	Grijs	289€	VEGECO32.GG
B120 x D46 x H105 cm	Antraciet	289€	VEGECO32.GA
B120 x D46 x H105 cm	Alu	318€	VEGECO32.AL
B120 x D46 x H195 cm	Grijs	355€	VEGECO33.GG
B120 x D46 x H195 cm	Antraciet	355€	VEGECO33.GA
B120 x D46 x H195 cm	Alu	389€	VEGECO33.AL



www.meabi.be



Een studiebureau dat naar u luistert en uw projecten op basis van 2D- en 3D-plannen realiseert in functie van uw behoeften

Verdeler:

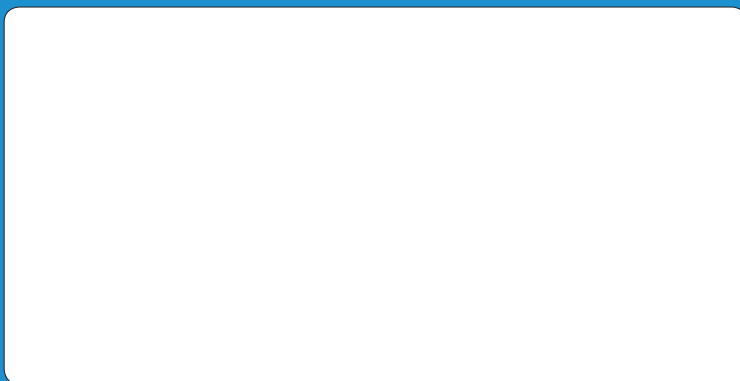

Verantwoordelijke uitgever: Marc Thyron
Route de Gembloux, 675 - 5020 Suarlée (België)

Foto's niet bindend. Alle prijzen zijn excl. btw. De prijzen in deze catalogus zijn geldig tot de verschijning van de volgende catalogus, behoudens drukfouten, uitputting van de voorraad en/of onmogelijkheid tot herbevoorrading tegen dezelfde voorwaarden. Indien de goederen niet in voorraad zijn, bedraagt de leveringstermijn 4 weken.